



**A research and delivery foundation for the facade  
design process utilising building  
Information modelling**

Student: Danny Birrell September 2014

Supervisor's: Stephen Emmitt / Stephen Ledbetter

Department of Architecture and Civil Engineering  
The University of Bath

**Sept 2014**

MSc Architectural Engineering: Façade Engineering

Access & Confidentiality: Normal

Word count: 21,876

## Abstract

BIM (building information modelling) is perceived as a more efficient way to deliver projects providing less room for errors and more possibilities for improvement in the AEC (Architecture, Engineering and Construction) industry. The UK government has undertaken several initiatives to reduce public sector construction costs by 20%, BIM has been identified as one of the initiatives in order to achieve this and has set a mandate for level 2 BIM on all public sector projects by 2016, BIM therefore can no longer be ignored in the UK construction industry. In many publications and surveys, it is argued that BIM is set to revolutionise the delivery of construction projects unlocking more efficient methods of working, and will promote a more a more structured collaborative approach to project delivery. However it is also suggested that the construction industry is ill prepared for the challenges BIM will present.

The government strategy for level 2 BIM by 2016 has raised a number of questions and concerns with regards to BIM implementation in the façade industry; research shows that there is currently a lack of knowledge, awareness and understanding with regards to BIM hence the reason why adoption levels remain low. As BIM is fuelled by 3D BIM software, it is debated that the design process is the first and most important process to master on the BIM journey, and is arguably one of the most important aspects of the construction lifecycle.

This research examines the façade design process, and has been developed in order to provide façade contractors with a better understanding of the transition to collaborative 3D BIM, and how to successfully manage the façade design process through a 3D environment. 3D BIM software is perceived to be the 'oxygen of BIM' a big part of this research analyses the approach to utilising the software along with the associated tools and technology that have been specifically developed to work in conjunction with BIM.

The output of this research delivers a BIM execution plan which is designed to provide a basic platform to facilitate successful BIM implementation. It is anticipated that not only will the execution plan provide a structured approach to BIM implementation for the façade design process; it will also increase the level of understanding of the BIM workflow and provide a foundational framework for its execution. The content of this paper will increase the level of BIM knowledge amongst façade contractors in order to increase competence and compliance, and will help increase adoption levels prior to the 2016 government mandate.

## Declaration

I hereby declare that my dissertation “A research and delivery foundation for the facade design process utilising building Information modelling” is comprised of my own personal work and research except where mentioned and referenced within the body of the text. A complete list of the references is included.

Danny Birrell

Date: September 2014

## Acknowledgements

Although the following dissertation is comprised of my own personal work, I could never have reached this far without the help, support, and contribution from others.

Firstly I would like to express my thanks Glassolutions for allowing me the opportunity to undertake this MSc Facade Engineering Degree, and the support they have provided me throughout my study.

I would especially like to thank Andy Woods for his encouragement and support during this process, your advice on both research and my career has been invaluable.

I would also like to express my gratitude to Dr Steve Lo and Professor Stephen Emmit for their help and guidance throughout the time of my dissertation research.

A special thanks to David Corcoran for his help and advice during the structural engineering unit, top man!

I would like to thank John Orrell of DLA architects for his contribution during the early stages of this research, your advice and guidance proved to be invaluable and helped form the direction of this research.

A special thanks to Tim Anderson of DLA architects for his assistance and advice in relation to Autodesk Revit, your input assisted with a significant part of this research.

A special thanks to my family. Words cannot express how grateful I am to my mother and father for all of the support they have given me over the years and to Laura and Kristian for their patience and support during the time spent away from home and throughout this whole process.

## Table of Contents

<b>Abstract</b> .....	<b>1</b>
<b>Declaration</b> .....	<b>2</b>
<b>Acknowledgements</b> .....	<b>3</b>
<b>Table of Contents</b> .....	<b>4</b>
<b>List of Figures</b> .....	<b>7</b>
<b>Abbreviations</b> .....	<b>9</b>
<b>1 Introduction</b> .....	<b>10</b>
1.1 What is BIM (building information modelling) .....	10
1.2 BIM Drivers .....	11
1.3 The need for a delivery foundation and execution plan .....	14
1.4 Contribution to knowledge.....	16
1.5 Research objectives.....	17
1.6 Limitations to work .....	19
<b>2 Literature review</b> .....	<b>20</b>
2.1 Government construction strategy .....	20
2.2 Levels of BIM maturity .....	22
2.3 Level 2 BIM defined .....	23
2.4 PAS 1192-2:2013 .....	24
2.5 Desk based study of Academic journals.....	28
2.6 Anticipated benefits of BIM .....	33
2.7 Issues and barriers of BIM .....	38
2.8 BIM enabled software .....	39
2.9 Summary of literature review .....	49
<b>3 Methods and results</b> .....	<b>52</b>
3.1 Mace façade supply chain and BIM workshop .....	52
3.2 Email survey – appropriate levels of detail for BIM.....	54
3.3 Industry survey - current BIM adoption in the construction industry.....	56
3.4 Interview with John Orrell RIBA & DLA.....	66

3.5	Summary of results and discussion.....	67
<b>4</b>	<b>Utilising BIM software for façade design .....</b>	<b>71</b>
4.1	The transition from 2D to 3D .....	71
4.2	Level of detail for BIM .....	72
4.3	Creating curtain wall details for BIM .....	72
4.4	Creating window & door details for BIM .....	80
4.5	Applying detail at the right time .....	84
<b>5</b>	<b>BIM design workflow and collaboration.....</b>	<b>89</b>
5.1	BIM Roles and responsibilities (people) .....	89
5.2	Collaborative working- the big room concept (people).....	92
5.3	Information exchange (process).....	96
5.4	Model approval and review process (process) .....	97
<b>6</b>	<b>Towards a reference BIM execution plan for the façade design process</b>	<b>101</b>
6.1	Introduction to the execution plan .....	101
6.2	Project Summary .....	102
6.3	BIM goals, uses objectives and deliverables .....	102
6.4	Project standards to be utilised .....	104
6.5	Roles and responsibilities .....	104
6.6	Model delivery schedule of information exchange.....	105
6.7	Collaboration process .....	106
6.8	Levels of detail / development.....	109
6.9	Model naming conventions .....	110
6.10	Quality control strategy .....	111
6.11	Project datum /coordinates .....	112
6.12	Design approval process.....	113
6.13	Training.....	113
<b>7</b>	<b>Discussion .....</b>	<b>114</b>
7.1	Areas of opportunity:.....	115
7.2	Limitations to work .....	115

<b>8 Conclusion</b> .....	<b>116</b>
8.1 Recommendations for future Work.....	119
<b>References</b> .....	<b>120</b>
<b>9 Appendices</b> .....	<b>126</b>
9.1 Appendix 1: Mace façade/BIM supply chain workshop comments .....	126
9.2 Appendix 2: Email survey - level of detail for BIM.....	127
9.3 Appendix 3: Industry email survey current BIM adoption.....	134
9.4 Appendix 4: PAS1192-2-2013 BIM roles defined.....	143
9.5 Appendix 5: PAS 1192-2-2013 Design statuts codes.....	144

## List of Figures

Figure 1.1: Virtual Design and Construction, (Bexel Consulting) .....	11
Figure 1.2: Industry consensus of BIM.....	14
Figure 1.3: BIM execution plan matrix.....	18
Figure 1.4: BIM mind map-work limitations .....	19
Figure 2.1: UK public sector expenditure .....	20
Figure 2.2: BIM maturity diagram, BIM Industry Working Group, (2011).....	22
Figure 2.3: People and processes, SEC group, (2012) .....	23
Figure 2.4: Principles for level 2 BIM.....	25
Figure 2.5: Contents of EIR, PAS 1192-2:2013. ....	26
Figure 2.6: Contents of post contract BEP, PAS 1192-2:2013 .....	28
Figure 2.7: Advantages of BIM, Yan and Damian (2008).....	29
Figure 2.8: Drawbacks of BIM, Yan and Damian (2008).....	29
Figure 2.9: Three interlocking Fields of BIM activity, (Bilal S 2009). ....	32
Figure 2.10: BIM Fields' overlapping players and deliverables Bilal S, (2009).....	32
Figure 2.11: Visualisation, Accuracy and aesthetics, (2008).....	34
Figure 2.12: Analyse and simulate, Sustain, (2014). ....	34
Figure 2.13: Big room Collaboration, Structure magazine (2013) .....	35
Figure 2.14: Model coordination and clash detection, Aeccafe blogs, 2013.....	35
Figure 2.15: Example of façade coordination error .....	36
Figure 2.16: Example of facade coordination error –plan view. ....	36
Figure 2.17: Reducing risk survey, Birrell, (2013).....	37
Figure 2.18: The BIM adoption J Curve, ANGL (2014) .....	38
Figure 2.19: BIM tool market share, Hamil S, (2013) .....	40
Figure 2.20: REVIT rendering, (2014).....	41
Figure 2.21: Typical 2D curtain wall detail .....	43
Figure 2.22: Over modelling example, Mcphee A (2012).....	49
Figure 3.1: Mace façade supply chain poll, (2014).....	53
Figure 3.2: High resolution widow detail.....	55
Figure 3.3: Stage 3 curtain wall detail.....	55
Figure 3.4: Ages of respondents .....	57
Figure 3.5: Years of experience .....	58
Figure 3.6: Job category of respondents.....	58
Figure 3.7: Number of people in organisation .....	59
Figure 3.8: Level of interest of BIM amongst clients in you market place .....	59
Figure 3.9: Do you currently use BIM or intending to use BIM in the near future? .....	60



Figure 3.10: What level of BIM is your company able to produce? .....	61
Figure 3.11: Primary function of BIM software .....	61
Figure 3.12: BIM enabled software used .....	62
Figure 3.13: Number of personnel dedicated to BIM. ....	63
Figure 3.14: Number of projects completed using BIM .....	63
Figure 3.15: Are you aware of the UK Government directive for BIM for 2016?.....	64
Figure 3.16: Do you have development plan for making the change to BIM? .....	64
Figure 3.17 key to successful BIM implementation .....	66
Figure 4.1: Revit mullion profile template .....	74
Figure 4.2: 3D view of mullion in BIM model .....	74
Figure 4.3: 3D view of offset mullion .....	75
Figure 4.4: 3D model lines vs 2D component lines .....	79
Figure 4.5: 2D detail overlay .....	79
Figure 4.6: Revit 3D model view of curtain wall section.....	80
Figure 4.7: 3D view of door in Revit Model.....	81
Figure 4.8: 2D section of door meeting stiles .....	81
Figure 4.9: 2D plan section of door jamb.....	82
Figure 4.10: Detail using Revit annotation function .....	82
Figure 4.11: Defined level of detail/development, BIM guide (nd) College of the desert ...	85
Figure 4.12: LOD-300, Outline of components .....	86
Figure 5.1: Roles and responsibilities, PAS-1192-2 (2013).....	91
Figure 5.2: Roles and responsibilities .....	92
Figure 5.3: BIM: A better way of working, David Philp (nd) .....	93
Figure 5.4: Spilt BIM coordination meetings .....	95
Figure 5.5: Mark up a Navisworks model, AEC bytes, (2012).....	98
Figure 5.6: Clash interference and detection, Autodesk (nd) .....	99
Figure 5.7: Autodesk design review .....	100
Figure 6.1: AEC (UK) BIM standard CDE, 2012. ....	107

## Abbreviations

AEC - Architecture, Engineering and Construction

BIM - Building Information Modelling

CAD - Computer Aided Design

IFC - Industry Foundation Classes

NBS- National Building Specification

RIBA -Royal Institute of British Architects

ROI - return on investment

BEP - BIM execution plan

EIR –Employees information requirements

PIP - Project implementation plan

LOD -Level of Detail/Development

CDE -Common data environment

## 1 Introduction

### 1.1 What is BIM (building information modelling)

BIM (Building information modelling) has been defined as “a set of interacting policies, processes and technology’s generating a methodology to manage the essential building design and project data in digital format throughout the building’s life cycle” (Bilal S 2009).

Practical implementation of BIM comprises the integration of the major functions of the construction process into a computer-generated environment in order to increase the level of efficiency during the construction life cycle. The speculation of BIM is that it will improve the construction industry and will lead to major benefits such as:

- Improved design consistency.
- Clash detection.
- Accurate visualization.
- Improved design collaboration techniques.
- Optimal project delivery.
- More reliable base for decision making.
- Reduction in design and scheduling errors.
- Improved project delivery and programming.
- Better preconception of the energy performance of the building.

The implementation of BIM will allow construction projects to be fully visualised at the early planning stages allowing virtual simulations of the building to be reviewed by the client and construction team. As such, BIM will provide potential beneficial project outcomes enabling the rapid analysis of different scenarios related to the performance of a building through its life cycle (Schade et. al 2011). It is anticipated that BIM will enable all of the project information to be stored in one central location as opposed to spread out over multiple servers, facilitating easy access to project information and data at each stage of the project lifecycle.



**Figure 1.1:** Virtual Design and Construction, (Bexel Consulting)

BIM can be viewed as a virtual process that encompasses all aspects of the construction project within a single model, allowing the project teams to collaborate and coordinate their work package with other parties creating a more integrated approach to project delivery. BIM will enable the project or facility to be built twice, once in a virtual environment and once on the construction site, with the intention being that the model is as accurate as possible prior to starting on site.

## 1.2 BIM Drivers

BIM is perceived as a more efficient way to deliver projects providing less room for errors and more possibilities for improvement in the AEC industry. The UK government has undertaken several initiatives to reduce public sector construction costs by 20%, BIM has been identified as one of the initiatives in order to achieve this and has set a mandate for level 2 BIM on all public sector projects by 2016, BIM therefore can no longer be ignored in the UK construction industry.

The government strategy for level 2 BIM by 2016 has raised a number of questions and concerns with regards to BIM implementation and what it actually means for the future of the façade industry. In many publications and surveys, it is argued that BIM is set to revolutionise the delivery of construction projects unlocking more efficient methods of working, and will promote a more structured collaboration process between the key stake-

holders throughout the construction lifecycle. However it is also suggested that the industry is ill prepared for the challenges BIM will present.

**Key challenges of BIM implementation for the façade industry:**

- Understanding what level 2 BIM is.
- ROI (return on investment).
- Understanding the relationships and responsibilities.
- How the design review/approval process will work.
- How the collaboration process will work between the project team.
- Understanding the level of detail in the BIM environment for façade design.
- Lack of BIM standards or guidelines specifically for the façade industry.

Countering the potential benefits of BIM to project is the challenges that need to be overcome if effective multi-disciplinary collaborative team working, supported by the optimal use of BIM, is to be achieved. Not least the changing roles of key parties, such as clients, architects, contractors, sub-contractors and suppliers, the new contractual relationships and the re-engineered collaborative processes (Sebastian, R., 2011). There is also the fragmented nature of the construction industry to consider, which means that knowledge gained by a team during the undertaking of a project is often not retained and used on future projects. It is not clear whether BIM is able to overcome this structural problem (Lindner and Wald, 2011).

Figure 1.2 summarises the general consensus from industry surveys, senior sources and views of the major façade contractors in the UK.

<b>Year</b>	<b>Source</b>	<b>Summary of Findings</b>
<b>2011</b>	Dr John Connaughton CIOB (2011).	You have to approach the design and construction processes differently, you have to share information rather than hold onto the bit you think is yours. It is a fundamental change in how people approach their discipline.
<b>2011</b>	Claire walker- leader of the think BIM network (2011).	Whilst the new construction strategy clearly sets the goal of Level 2 BIM on public projects there is as yet no clear roadmap to achieving this and overcoming some of the issues associated with skills and knowledge gaps which are critical to effective BIM deployment within a short few years.
<b>2012</b>	NFB BIM readiness survey (2012).	The survey indicates a widespread awareness of BIM and a recognition of its likely importance to the respondents 'businesses and their clients, but a low level of understanding of BIM.
<b>2013</b>	NBS National BIM Report (2013).	Although the numbers using BIM continue to grow, a lack of clarity around the subject was identified by the survey as an obstacle to more rapid adoption, with 74% agreeing that 'the industry is 'not clear enough on what BIM is yet.
<b>2013</b>	NFB BIM Client Readiness Survey (2013).	A lack of understanding is a barrier to both demand and adoption of BIM.
<b>2014</b>	Elmualim A & Gilder J (2014)	The results showed that there is a need for increasing awareness, education and research work to stipulate the potentialities of using BIM.

<b>2014</b>	<p><b>UK façade contractors:</b></p> <p>Glassolutions-Saint-Gobain,          Permasteelisa          Fendor          Focchi,          Lindner Schmidlin,          Yuanda,          Prater          Dane Architectural,          Lakesmere          GIG,          Fleetwood          Colorminium group,          Far East Facade UK Ltd</p>	<p>An industry standard BIM protocol and execution plan is needed.</p> <p>It is anticipated that BIM will unlock new and more efficient working methods, however as it is not yet fully understood.</p> <p>We are actually increasing tender prices to cover the 2d and 3d aspects of the design process.</p> <p>When utilising BIM, how will the design approval process work?</p> <p>Autodesk Revit is not sophisticated enough for façade design.</p> <p>BIM software is good for visualisation, but not appropriate for the level of detail required for façade interfaces.</p>
-------------	---	---

**Figure 1.2:** Industry consensus of BIM

There is high degree of uncertainty and questions surrounding BIM amongst the major façade contractors, more clarity is also needed to ensure that BIM will provide a ROI. The BIM guidelines and standards published by the government only provide general recommendations on how to implement BIM, considering the complexities of façade design these recommendations are not explicit enough; an industry standard protocol is needed in order to help façade contractors understand BIM and its processes.

### 1.3 The need for a delivery foundation and execution plan

Building facades are arguably one of the largest and most important aspects of construction as it is responsible for the overall technical performance and aesthetic appeal of a building. With this in mind along with the added complexities of architectural trends, it is important the shift from 2D to 3D BIM for façade contractors is clearly defined in terms of workflow, protocol and execution.

The key objective of this paper is to create a BIM delivery foundation for the façade design process in order to provide façade contractors with a basic level of understanding of what

BIM is, a foundational framework for its implementation, and how the design process will be approached and managed through a 3D environment. This research starts with a review of BIM literature such as the government strategy report and PAS1192-2 in order to understand the reasons why BIM is being labelled the future of the construction industry, and the guidance available for its implementation.

As 2016 is upon us, this paper will clearly outline what level 2 BIM means in terms of its processes, protocol and will outline the anticipated benefits of its implementation. It is suspected that parts of the industry have already adopted BIM, a survey will be conducted to understand current adoption levels in the industry and to identify who is leading way, what the potential barriers are, commonly used software and the industry perception on the keys to successful BIM implementation.

BIM enabled software is analysed in detail in order to understand the limitations and capabilities when being utilised for façade design, and will analyse the transition from the traditional 2D approach to working in a 3D environment. In conjunction with this, the appropriate level of detail for BIM in coincidence with the façade design process is analysed and tested using Autodesk Revit, along with an additional survey to establish the industry's views on the appropriate level of detail for façade design when utilising BIM.

A study of the design review process, information exchange and collaboration for BIM is undertaken which is categorised into people and processes, this also includes a review of the technology and tools available that have been specifically developed to work in conjunction with BIM.

The last chapter of this paper will be a systematic execution plan for the façade design process for level 2 BIM, designed to help façade contractors understand the BIM workflow and the key processes in order to successfully manage the façade design process when adopting BIM.

Despite widespread uncertainty with regards to BIM implementation, it is perceived to be a more efficient way to approach construction as it has the potential to optimise the planning, collaboration and control of construction projects. This research will improve the level of BIM knowledge and competency amongst façade contracts, and will give them the ability to engage with clients to discuss the approach to BIM for the façade elements of the project. 'BIM capability statements' are becoming more common as part of the tendering process, therefore having sufficient level of BIM competency and the ability to comply with BIM requirements may lead to commercial advantages.



#### **1.4 Contribution to knowledge**

- There is widespread belief that façade industry is ill prepared for the challenges of BIM, this paper will raise the awareness of BIM adoption in the façade industry and will provide a better understanding of this new virtual process.
- This research will outline the importance and the benefits of team collaboration when implementing BIM for construction projects in the UK.
- This research will provide a foundational framework for level 2 BIM in accordance with current BIM standard and protocols.
- There are no standard guidelines or protocol for the façade industry hence the low level of understanding and adoption, the output of this research will help the façade industry understand the fundamental requirements for façade design utilising BIM.
- The output of this research will increase the level of BIM knowledge amongst façade contractors in order to increase BIM competence and adoption levels.
- It is not yet understood if BIM enabled software can accommodate the level of detail required for façade interfaces, this research will analyse the constraints and the capabilities of BIM enabled software and will propose a solution to achieve the appropriate level of detail for façade design.

### 1.5 Research objectives

Research Objectives	Research method	Chapter
1. Clarify the goals and anticipated benefits of BIM	<ul style="list-style-type: none"> <li>• Desktop study of publications and journals.</li> <li>• Desktop study of PAS 1192:2</li> </ul>	2
2. Examine the current adoption levels of BIM in the construction industry	<ul style="list-style-type: none"> <li>• Personal communications</li> <li>• BIM workshop</li> <li>• Industry Questionnaire</li> </ul>	2 & 3
3. Review and asses the barriers of BIM in the construction industry	<ul style="list-style-type: none"> <li>• Industry questionnaire</li> <li>• Desktop study of online literature</li> <li>• Desktop study of academic journals</li> </ul>	2 & 3
4: Establish the appropriate level of detail for façade design when utilising BIM enabled software.	<ul style="list-style-type: none"> <li>• Industry Questionnaire</li> <li>• Personal communications</li> <li>• Computer based study of Revit</li> </ul>	3 & 4
5. Examine the capabilities of BIM enabled software.	<ul style="list-style-type: none"> <li>• Computer based study of Revit</li> <li>• Personal communications</li> <li>• Desktop study of online journals/forums</li> </ul>	2 & 4

<p>6. Examine the transition from 2D to 3D design.</p>	<ul style="list-style-type: none"> <li>• Desktop study of online literature</li> <li>• Desktop study of design review technology</li> </ul>	<p>4 &amp; 5</p>
<p>7. Develop a towards reference BIM execution plan to improve the façade design process.</p>	<ul style="list-style-type: none"> <li>• Evaluation of findings from questionnaires &amp; personal communications</li> <li>• Desk based collation of research findings</li> </ul>	<p>6</p>

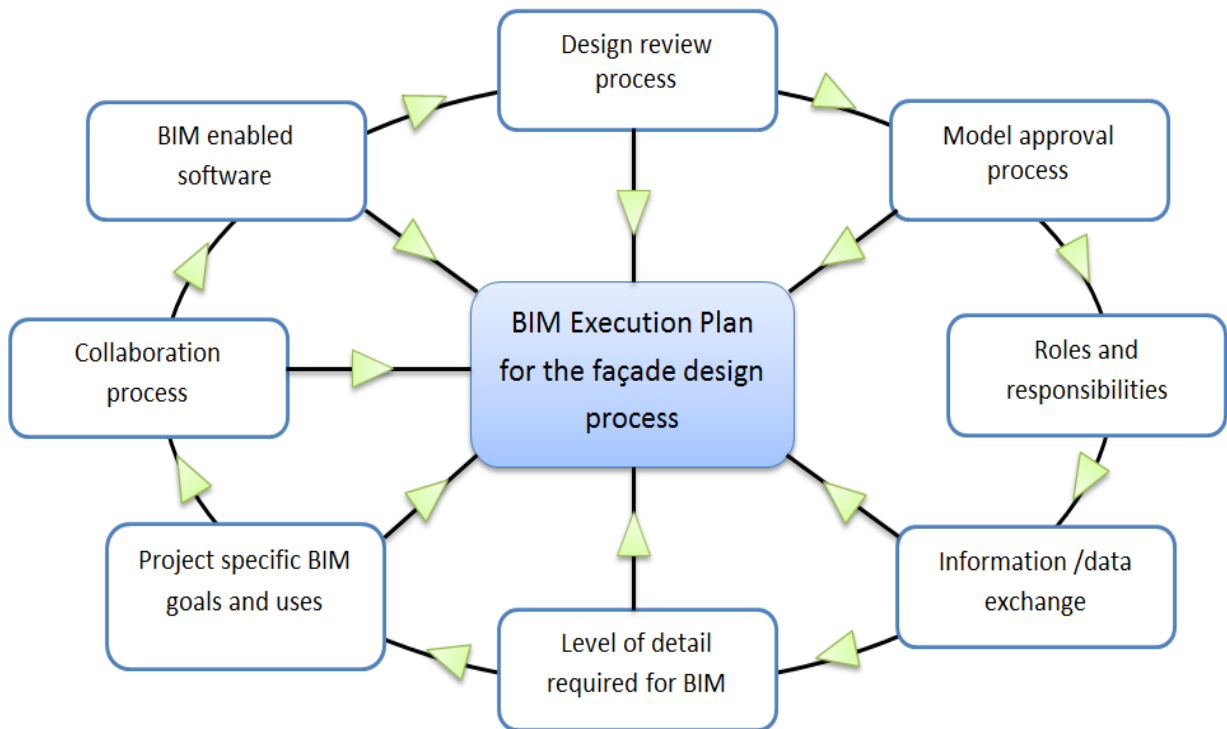


Figure 1.3: BIM execution plan matrix

### 1.6 Limitations to work

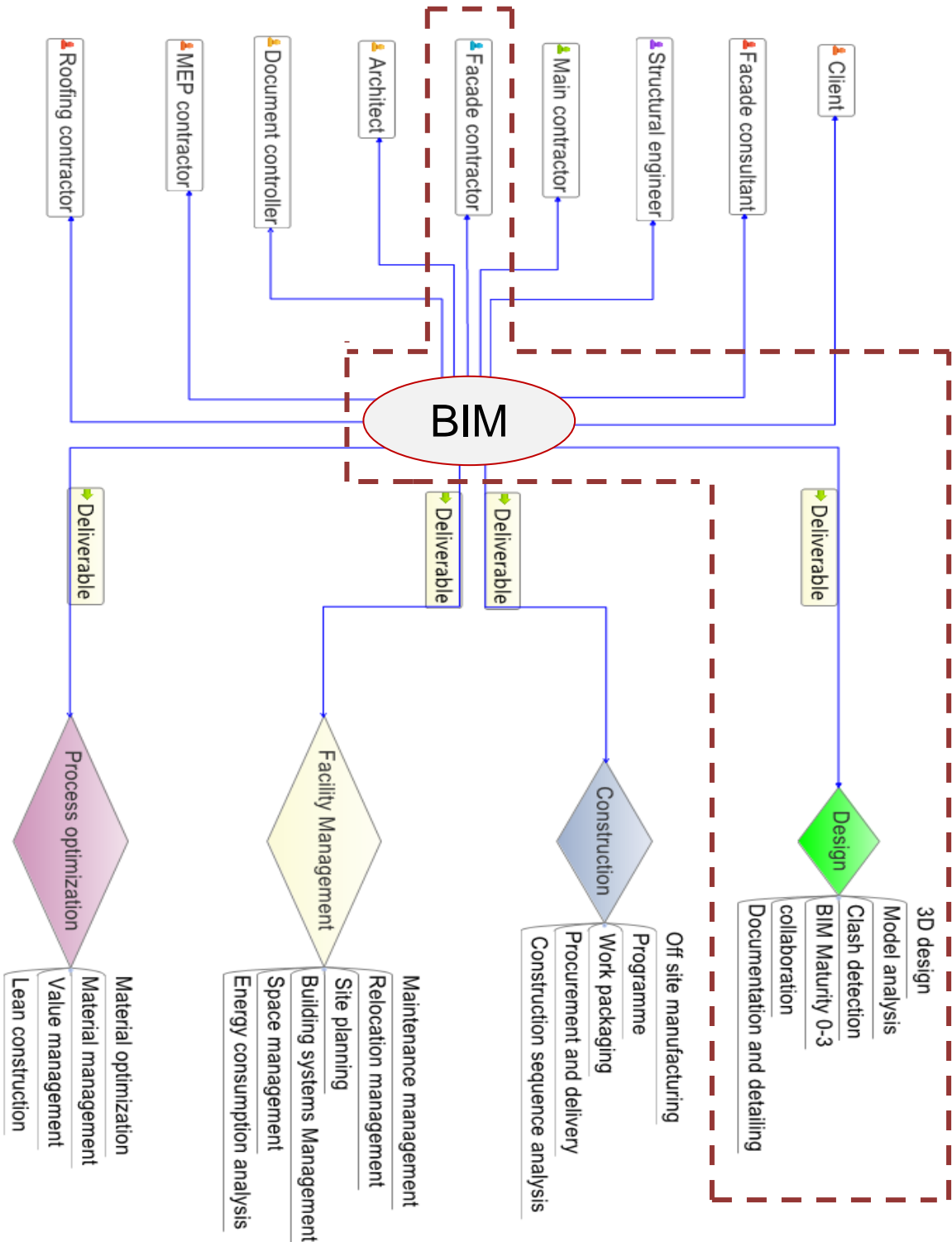


Figure 1.4: BIM mind map-work limitations

## 2 Literature review

### 2.1 Government construction strategy

The UK construction sector represents 7% of the Gross Domestic Product which is approximately £110bn per annum of expenditure with 40% of this being in the public sector. The government construction strategy issued in May 2011 outlines the weaknesses in the industry which are related to lack of integration, inconsistent procurement methods, and lack of investment. This is compounded by fragmented nature of the industry and the lack of standardisation which has led to inconsistent working methods, a change is required in order to improve efficiency and to provide opportunities for growth in the public sector.

The Government being the construction industry's biggest customer has recognised that that major improvement is required in order to reduce costs related to project delivery. A fundamental change is required to improve the collaboration and management of information on UK construction projects to achieve the 20% reduction in capital cost set by the Government.

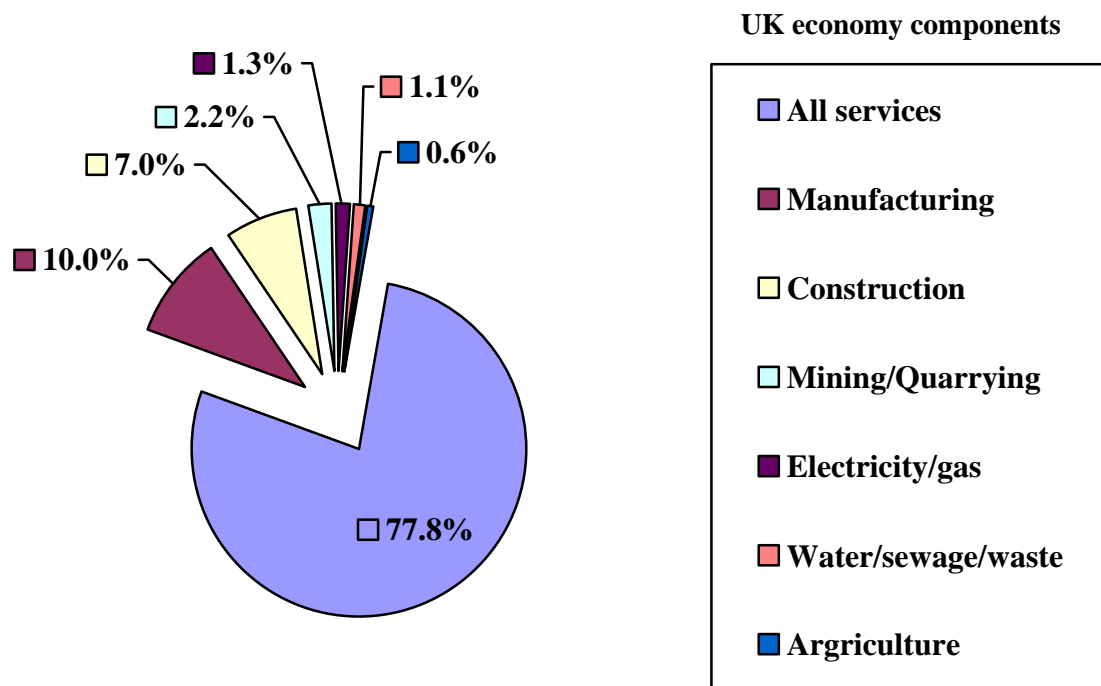


Figure 2.1: UK public sector expenditure

One of the key strategy objectives to improve the UK construction industry is the adoption of BIM, which is the process of working through a fully collaborative 3d environment. Other Industries such as the automotive and aerospace have been using BIM for over 20 years allowing them to accurately produce virtual 3D models of parts and components enabling them to refine their products and processes to a high standard to facilitate excellent quality and reliability. Compared to the fragmented construction industry, the automotive and aerospace industries have very compact supply chains with a handful of standardised products and components which have been refined over the years with research and development providing commercial benefit and continued innovation.

Other industries have realised the full potential of 3d BIM, it is stated in the Government strategy that the construction industry is lagging behind and have yet to release the benefits of 3D digital technology. The plan to bring the construction industry up to speed with 3D technology was outlined by the Government in 2011:

*“Government will require fully collaborative 3D BIM (with all project and asset information, documentation and data being electronic) as a minimum by 2016. A staged plan will be published with mandated milestones showing measurable progress at the end of each year”* (Government construction strategy, 2011).

To drive this change, a BIM mobilisation and implementation group was formed and met for the first time in May 2011 in order to create a report to inform the construction industry of their findings. The report outlines the aims and objectives of the working group and the proposed strategy for the implementation of BIM including anticipated deliverables. The report recognises the barriers of BIM which mainly relate to changes in working standards, processes, and the requirement for education and training; it also provides brief recommendations on how to overcome these barriers. Walker C, (2011) suggests that there is no clear road map to help overcome some of the barriers of BIM, and there is currently a lack of knowledge in the industry to enable effective BIM implementation.

In 2013, nationwide BIM readiness surveys were conducted by the NBS (National bureau of standards) and NFB (National federation of builders). Both surveys highlight that 74% of the industry were still not clear on what BIM actually is, and adoption levels will remain low until it is believed that it will bring a benefit to the business. The barriers of adoption are summarised as learning new tools and techniques, lack of client demand, lack of technical skills and willingness to invest time, effort and cost in something they don't understand. Both surveys however imply that those who have adopted BIM can see

the benefits it will bring to project delivery, and 75% of responders agree that BIM is the future of the construction industry.

## 2.2 Levels of BIM maturity

The BIM Maturity Diagram devised in 2008 by Mark Bew and Mervyn Richards was created to illustrate the current level of information exchange between the construction supply chains. The target set by the government is to have fully collaborative level 2 BIM on all public sector projects with all data and documentation being electronic by 2016.

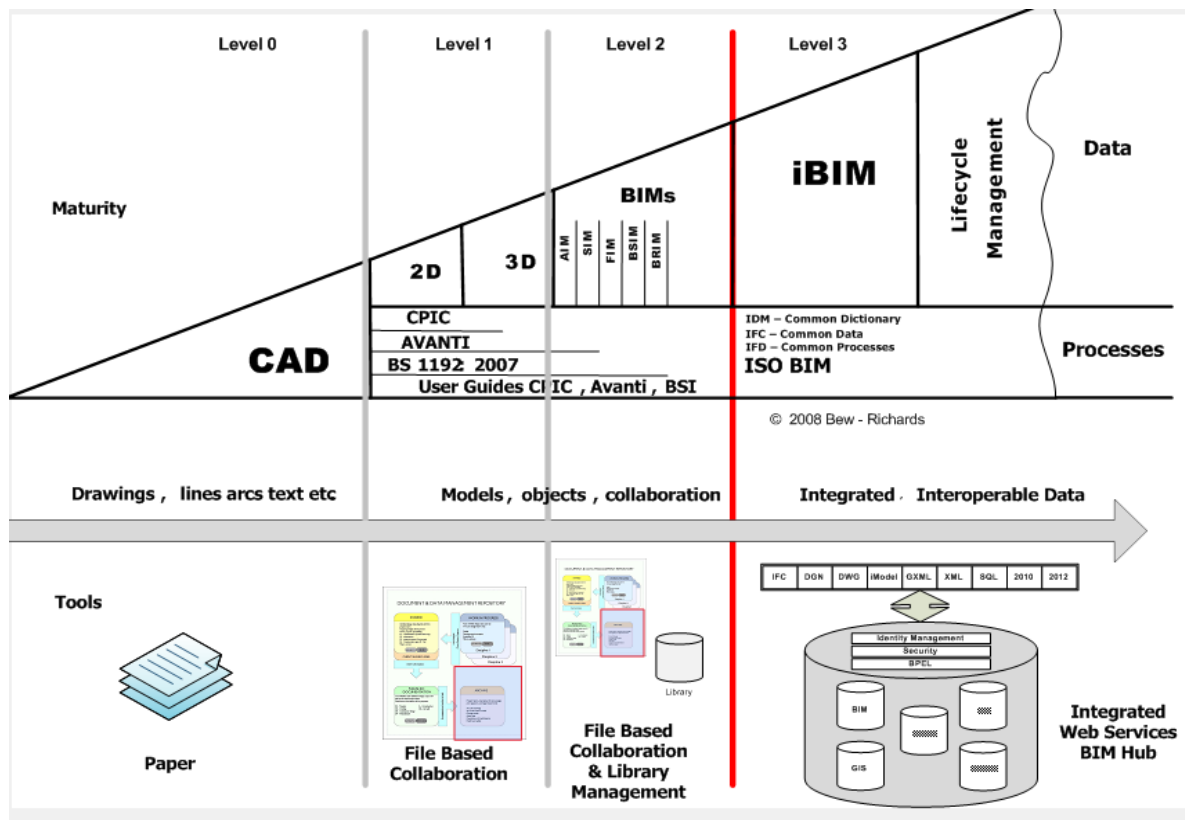


Figure 2.2: BIM maturity diagram, BIM Industry Working Group, (2011)

The BIM maturity diagram illustrates technology and data exchange, level 0 at the bottom end of the scale represents current practice in the industry which is generally 2D CAD (computer aided design) with paper or electronic data exchange mechanisms. At the top end of the scale is level 3 BIM, which is perceived as the 'holy grail' of BIM maturity comprising a single working model allowing each party to work in the virtual environment concurrently, this is commonly known as iBIM or integrated BIM managed by a collaborative model server, however it is suggested that the technology and services to facilitate level 3 BIM does not yet exist. The first step for the industry is to achieve level 2 before looking beyond it.

The levels of BIM maturity are defined as follows:

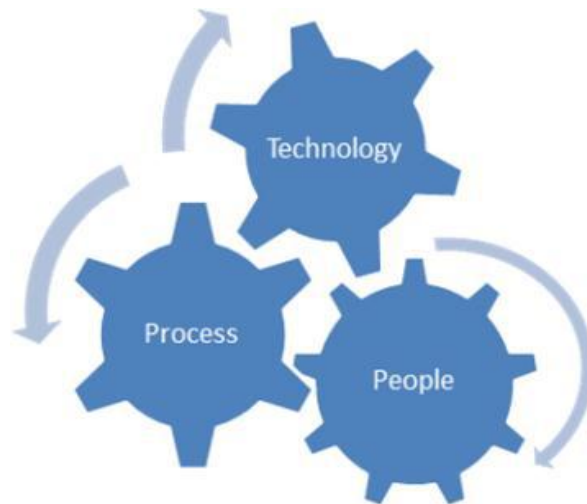
**Level 0** – 2D issue of information which is unmanaged and without utilising a CDE (common data environment)

**Level 1** – 2D or 3D CAD information developed by individual parties on standalone formats and coordinated through an online CDE tool with not integration.

**Level 2** – 3D environment produced by separate disciplines with associated project data attached, which can be federated using BIM enabled review software to facilitate clash detection, efficient design collaboration/integration and project planning.

**Level 3** – Comprises a fully integrated design process with a single working model whereas separate disciplines can work in the 3D environment concurrently throughout the project lifecycle.

SEC group (2012) suggest that BIM is not just about the technology and the use 3d software, the key behind this new innovative development is the people and how well they can adapt to this new way of delivering construction projects.



**Figure 2.3:** People and processes, SEC group, (2012)

### 2.3 Level 2 BIM defined

Level 2 BIM can be defined as a managed 3D CDE comprising a series of native models prepared by each party with project specific data attached; these models are then issued to a central location where they can be checked by the appointed person and given the



appropriate status code in accordance with PAS1192-2. Once the models are validated, they can then be federated to create a single 3D model in order to create a virtual CDE which can be used for clash detection, accurate coordination of multiple design packages, 3D visualisation and analyses.

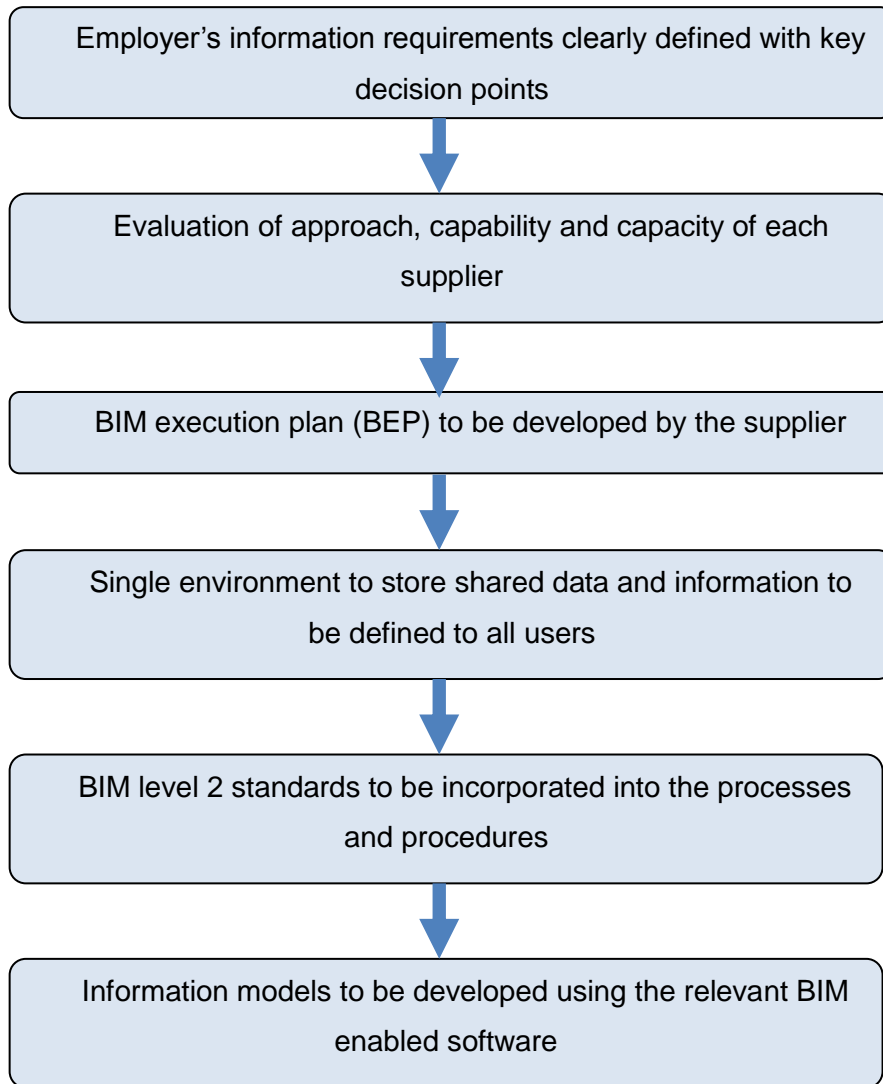
An important consideration for level 2 BIM is model interoperability, IFC (Industry Foundation Classes) can be used as a neutral exchange format which allows the native models to be viewed without having to support numerous software formats used by each party. The output of each model should be agreed and documented in the BEP (BIM execution plan) to ensure successful BIM collaboration. The number of models for the project and their purpose must also be set by the client at the start of the project along with set procedures and protocol.

It is important to note that Level 2 BIM should not alter the traditional design responsibilities or protocol; each project team member will still be required to produce design information specifically related to their works based on the project specification and the architectural and structural information. Although design responsibilities will not differ, it is important that the design protocol is fully understood and managed throughout the design process.

Many law firms and insurance companies suggest that the implementation of BIM and the increased level of electronic data exchange during the construction life cycle will create an increased level of cyber risk, potential threats being malicious outsiders and insiders causing reputational risk, security risks and corruption of data. BIM has a high dependency on IT therefore it is important that the risks are recognised and managed throughout the construction lifecycle. Data exchange strategies and responsibility's should be clearly defined in the BEP and sub-contracts in order to mitigate 'cyber risk' and to help safeguard insurance policies.

#### **2.4 PAS 1192-2:2013**

PAS 1192-2 was released in 2013 which outlines the specification for information management for the delivery of projects when using BIM. The purpose of the document is to support level 2 BIM maturity by setting chains of responsibility's for BIM projects providing guidance and recommendations for the approach to collaborative working, methods and processes. The principles of PAS 1192 in terms of workflow are outlined in figure 2.4 below.



**Figure 2.4:** Principles for level 2 BIM

PAS1192-2-2013 states that the EIR's (employee's information requirements) should be incorporated into the tender documents to enable suppliers and contractors to produce a BEP specifically for the project. These requirements are in order to determine if the EIR's are achievable, and to evaluate if the potential suppliers or contractors have the capacity and capability of meeting level 2 BIM requirements. Figure 2.5 outlines the minimum information requirements to be provided by the employer (pre-contract).

<b>Contents of the EIR's</b>		
<b>Technical</b>	<b>Management</b>	<b>Commercial</b>
Data Exchange Format	Roles and Responsibility	Timing of data drops
co-ordination/clash detection	Planning the work	Clients Strategic Purpose
Level of Detail (general)	Collaboration process	Definitive BIM deliverables
Schedule of BIM standards	Compliance Plan	Competence assessment details
Training requirements	schedule of constraints	Software Platforms
Data segregation	Delivery strategy	HSE/CDM – requirements
Maximum model size	Changes of any roles or responsibilities	Security/integrity requirements

**Figure 2.5:** Contents of EIR, PAS 1192-2:2013.

In many sources it is debated that the EIR requirements for level 2 BIM outlined in PAS 1192:2 assumes a 'perfect world' and that the project brief will be clearly defined at such an early stage which is highly unlikely. Serious questions were raised during a level 2 BIM workshop (2013) comprising multi-disciplinary teams to whether clients would have enough information available at the early stages of a project to be able to write clear EIRs (live workshop 2013). Questions were also raised with regards the level of client knowledge, and whether they were even capable of providing this level of information, PAS1192-2-2013 however does recommend that employers should to assign the role of a

‘project delivery manager’ and ‘information manager’ as early as possible in order to develop the project requirements in line with the EIR’s.

Following the development of the EIRs listed in table 2.5, the principal contractor should then produce a pre-contract BEP aligned with EIR’s plus the following information:

- a) The project implementation plan (PIP)
- b) Project goals for collaboration and information modelling
- c) Major project milestones consistent with the project programme
- d) Project information model (PIM) deliverable strategy

(PAS 1192-2:2013)

As part of the PIP, the principal contractor should evaluate the capabilities of their supply chain to ensure that they are able to meet the requirements set out in BEP. This is done via a ‘BIM assessment form’ which is issued to the supplier/specialist contractor as part of the tender documentation. PAS 1192-2:2013 summaries the key items to be included in the post-contract BEP (figure 2.6).

<b>Key items for post contract BEP</b>		
<b>Procedures</b>	<b>Management</b>	<b>IT solutions</b>
File naming conventions	Project milestones	Software versions
Layer naming conventions	Model delivery strategy	Exchange formats
Standard annotation	<b>PIP with supply chain capability</b>	Process data management systems
Drawing sheet templates	Collaboration process for BIM	

Roles and responsibilities	<b>Matrix of responsibilities in supply chain</b>	
Approval of information	Material information delivery plan (MIDP)	
Agreed construction tolerances	task information delivery plan (TIDP)	

**Figure 2.6:** Contents of post contract BEP, PAS 1192-2:2013

It is unclear in PAS 1192-2:2013 if multiple BEP will be required for the project considering multiple appointments of specialist contractors. It is recommended that facade contractors develop their own BEP in accordance with the key requirements in the post contract BEP, but also defining specific requirements for the facade design work flow such as key milestones, facade design related processes and inline their own internal processes. It is better to start with a plan defining what you want as opposed to what others demand.

PAS 1192-2:2013 is reference document written by experts for people with BIM knowledge and experience, it is not designed for the inexperienced. The document does however clearly map the responsibilities of the employer and the principal contractor, but fails to provide guidance or protocols for specialist contractors. The terminology in this document is difficult to interpret and can be confusing at first i.e. LOD, BEP, IFC etc. an important step towards BIM compliance is to learn and understand the common language and terminology associated with the BIM workflow.

Chapter 2.5 is based on the findings from academic sources which summarises the general consensus of BIM in terms of the benefits, barriers and the key considerations for its implementation.

## 2.5 Desk based study of Academic journals

In many academic journals the construction industry is widely criticised for its inefficacy and its fragmented nature, Bilal S (2009) suggests that BIM is set to improve the industry's fragmentation and will facilitate a better and more efficient way to deliver construction projects. Azhar S (2011) argues that the use of a virtual 3D model for the construction

lifecycle will improve accuracy in the AEC industry therefore it must be recognised as promising development. Wong and Fan (2013) believe that BIM is an essential development which will reduce waste and add value to all stages of the construction lifecycle. They also suggest that being able to construct the building or facility virtually prior to construction will provide many benefits and will enhance the design and performance of buildings. A questionnaire carried out by Yan and Damian (2008) identifies the key benefits and the barriers to adopt this new technology. The results of this are illustrated in figure-2.7 and 2.8.

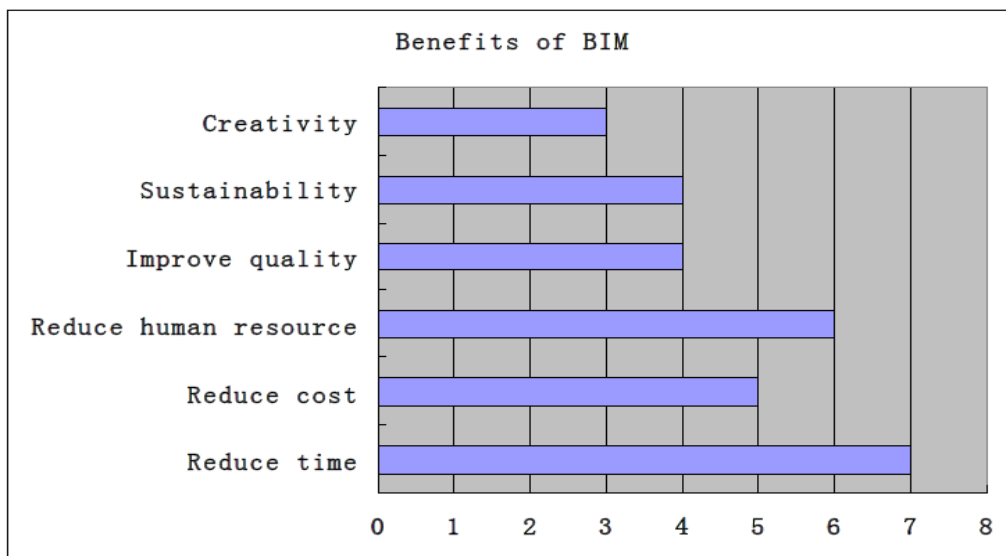


Figure 2.7: Advantages of BIM, Yan and Damian (2008)

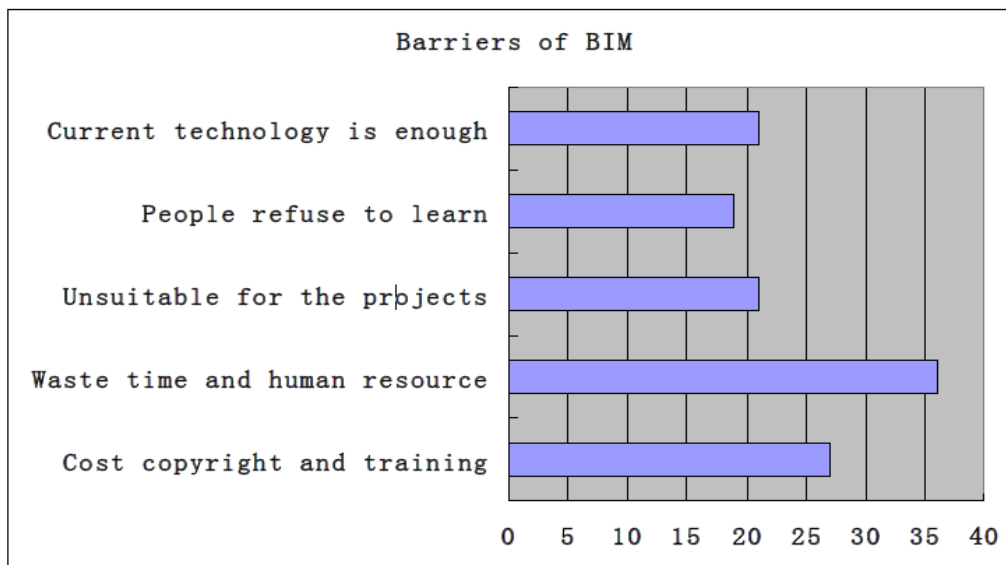


Figure 2.8: Drawbacks of BIM, Yan and Damian (2008)

This result also reflects that to reduce the construction time is the most significant benefit of using BIM. On the other hand, most of the companies who do not use BIM believe that BIM training would cost their companies too much time and human resource. This is the largest barrier to implementation of BIM (Yan and Damian 2008). Nonetheless, a widespread adoption of BIM is largely dependent on how the industry perceives its genuine benefits. Users who are to adopt BIM need to be encouraged by using empirical evidence. Investors also need to justify their investment of time and budget in BIM by discerning clear proof of its benefits. Research has shown that one of the major hurdles for adopting BIM is the justification of the additional cost and benefits (Li et al. 2009, cited by Lu et al. 2012). A survey carried out by Elmualim A and Gilder J (2014), indicated that there are various challenges that are facing the construction industry in the application of BIM. The three major factors ranked by the respondents were: training staff on new process/workflows; effectively implementing the new process/workflow; and understanding BIM enough to implement it. Other reasons were: training staff on new software/technology; establishing the new process/workflow; and realising the value from a financial perspective (Elmualim A and Gilder J 2014). Gu and London (2010) suggest that concerns are primarily on the technical, cultural/work practice and process/method related issues, with the technical concerns topping the list. FGI analysis reveals that the AEC industry's overall lack of experience in BIM, has led to their limited understanding and articulation of industry needs and technical requirements for BIM. Presently there is limited use and hence limited knowledge of BIM and their integration in the AEC industry (Gu and London 2010).

Gu and London (2010) suggest 4 key considerations for the implementation of BIM:

- Defining scope, purpose, roles, relationships and project phases.
- Developing work process roadmaps.
- Identifying technical requirements of BIM.
- Customisation of the framework and evaluating skills, knowledge and capabilities.

BIM adoption would require a change in the existing work practice. A different approach to collaborative BIM development is needed in public procurement settings where owner is bound to work with procedural and legal frameworks. Organizations should find ways to best incorporate the existing defined process and protocols in different phases of their projects. In addition, they should assign responsibilities of design reviews and validations appropriately (Porwal & Hewage, 2013).

Porwal & Hewage (2013) provide the following steps to evaluate BIM adoption capabilities:

- The need of guidance on where to start, what tools available, and how to work through legal, procurement and cultural challenges with the added technologies.
- Capabilities of project participants in BIM usage.
- Potential to move to the required BIM implementation level if not currently with such capacities.
- Training and support implications of key stakeholders.
- Lack of availability of required tools in a given project.
- Likely conflicts and risks due to change in work practices by the adoption of BIM.

Bilal S (2009) identifies 3 interlocking BIM activity fields which are processes, policy and technology. Each field comprises interactions and field overlaps (figure-2.9 & 2.10) which allows stakeholders to understand the underlying knowledge structures and BIM implementation requirements.

- The BIM Technology (Field Technology) – The Development of software, hardware and equipment.
- The BIM Process (Field Process) – This relates to the key project stakeholders who are responsible for the key processes during the construction lifecycle such as design, procurement, and manufacture, installation and facilities management.
- The BIM Policy (Field Policies) – This field is for research and development covered by regulatory bodies and educational intuitions to ensure benchmarks and standards are in place. It also covers contractual, risk allocation and the development of insurance policies.



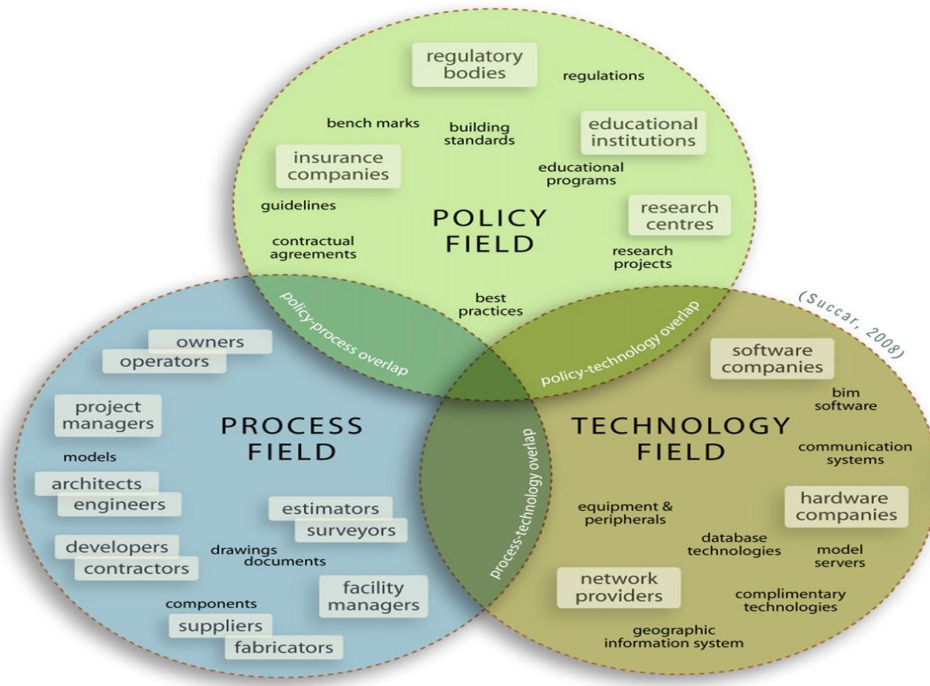
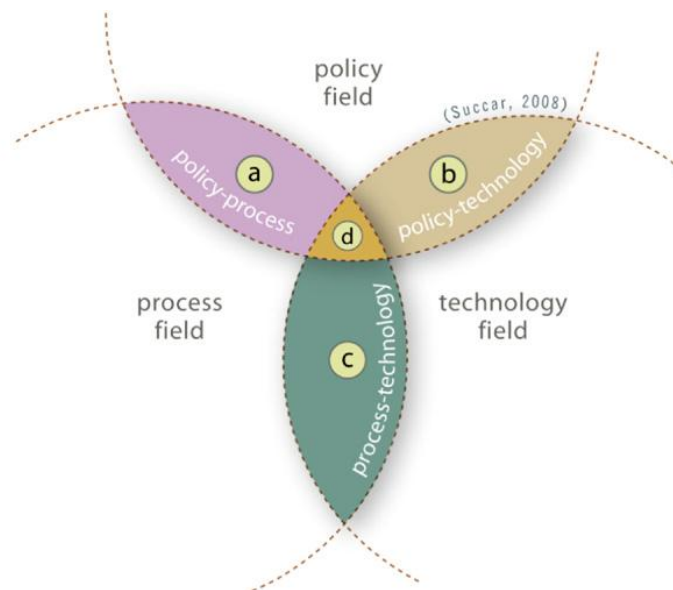


Figure 2.9: Three interlocking Fields of BIM activity, (Bilal S 2009).



Legend:

- a Sample **Policy-Process overlap**: Industry body (*BIM player*) and Continuous Professional Development (CPD) training (*BIM deliverable*)
- b Sample **Policy-Technology overlap**: Interoperability standards (*BIM deliverable*)
- c Sample **Process-Technology overlap**: Communities of Practice (*BIM player*)
- d Sample **Policy-Process-Technology overlap**: BIM Implementation (*BIM deliverable*), BIM specialists ñ individuals and groups (*BIM players*)

Figure 2.10: BIM Fields' overlapping players and deliverables Bilal S, (2009)

In terms of the benefits of BIM, the majority of academic journals provide similar statements with regards to better collaboration; improve efficiency, reduction of waste/time, and adding value to the project life cycle.

Lack of understanding, limited knowledge and lack of training are common statements made with regards to the barriers of BIM adoption. Other comments suggested that the industry needs to fully understand the technicalities of BIM before they invest in training and software. Although BIM is spreading in AEC industries worldwide, the need for qualified personnel remains a bottleneck of BIM implementation in new buildings. Other major hindrances are the willingness to collaborate and cultural differences (Volk et al 2013).

There are many similarities in academic journals with regards to key considerations for BIM adoption which are listed below:

- Defining roles, relationship's and responsibilities
- Developing workflow roadmaps
- Understanding the technical requirements of BIM
- Training
- BIM should Incorporate existing processes and protocols

Although on the one hand, implementation of BIM both in new and existing buildings induces profound changes of processes and information flows (e.g. through IPD), on the other hand it accrues considerable advantages (e.g. in risk mitigation or improved data management). (Volk et al 2013).

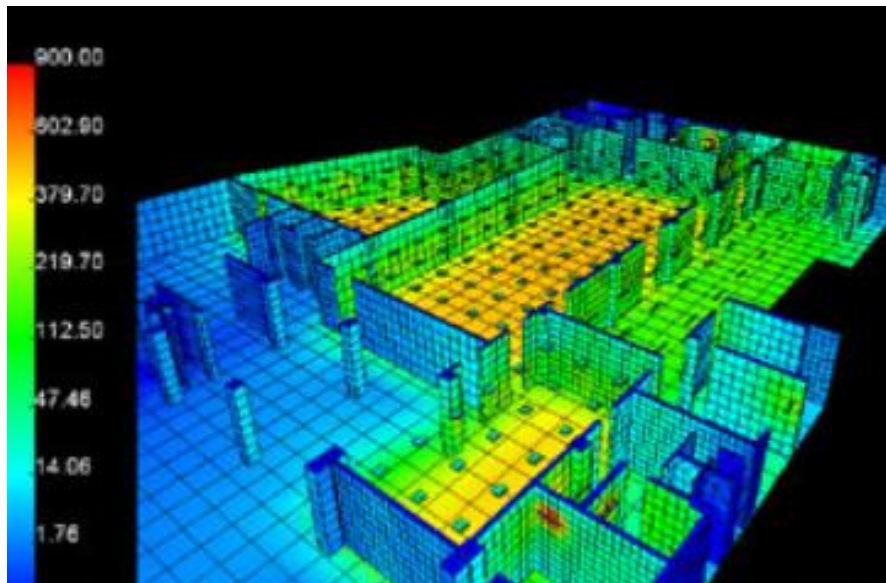
## **2.6 Anticipated benefits of BIM**

It is anticipated that BIM will add value across the entire building life cycle, and will provide more efficient workflows between parties due to the better visualisation the 3D environment will provide. Industries such as the aerospace and automotive have reaped the benefits of BIM implementation for years and have put BIM at the core of all of their processes, companies such as Boeing have achieved exceptional quality with their products by limiting the number of suppliers, refining their products and by standardisation. It is argued that the AEC industry can learn from this by approaching construction in the same way.

**Visualisation:** A 3D environment provides better visualisation and understanding of how the building components are constructed, and how they interface with other elements such as the structure and internal finishes (figure-2.11).



**Figure 2.11:** Visualisation, Accuracy and aesthetics, (2008).



**Figure 2.12:** Analyse and simulate, Sustain, (2014).

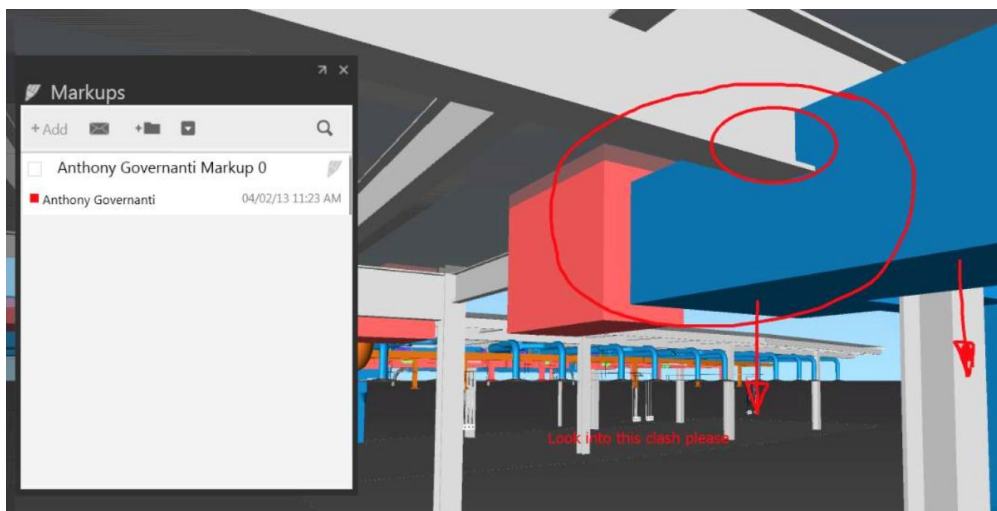
**Analyse and simulate:** BIM enabled software such as Autodesk Revit can provide whole building thermal performance analyses which can provide a better preconception of how the building will perform. Other tools available have the capability of analysing u-values, solar analyses, natural ventilation and can measure for sustainable building accreditation for BREEAM/LEED assessments (figure 2.12).

**Collaboration:** The ‘big room concept’ is the process of bringing together all of the key stakeholders and trades to facilitate a collaborative working. It is anticipated that BIM and collaborative working will achieve better and more predictable outcomes for construction projects (figure 2.13).



**Figure 2.13:** Big room Collaboration, Structure magazine (2013)

**Buildability & clash detection:** During the BIM collaboration process, the design can be integrated more effectively for buildability checks, construction sequence and to identify potential clashes with structure or services (figure 2.14). A typical example of a facade coordination error is illustrated in figure-2.15 and 2.16, it is anticipated that BIM will help identify these coordination errors during the early design stages as opposed to on the construction site which usually results in cost and programme implications.



**Figure 2.14:** Model coordination and clash detection, Aeccafe blogs, 2013

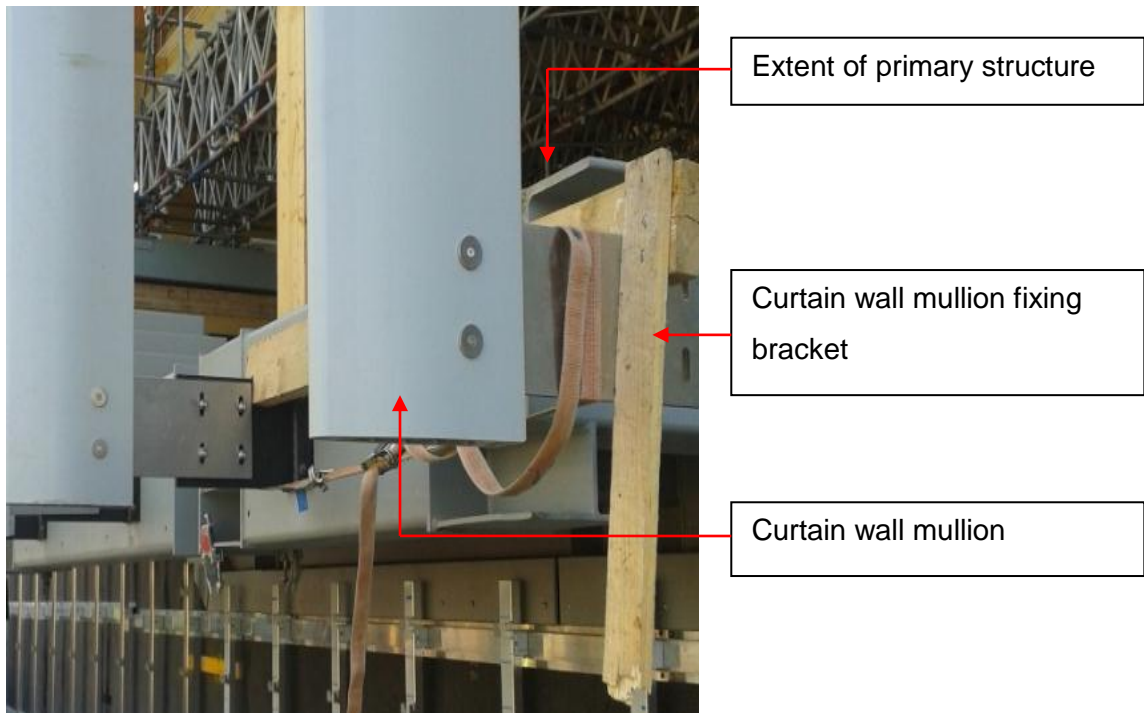


Figure 2.15: Example of façade coordination error.

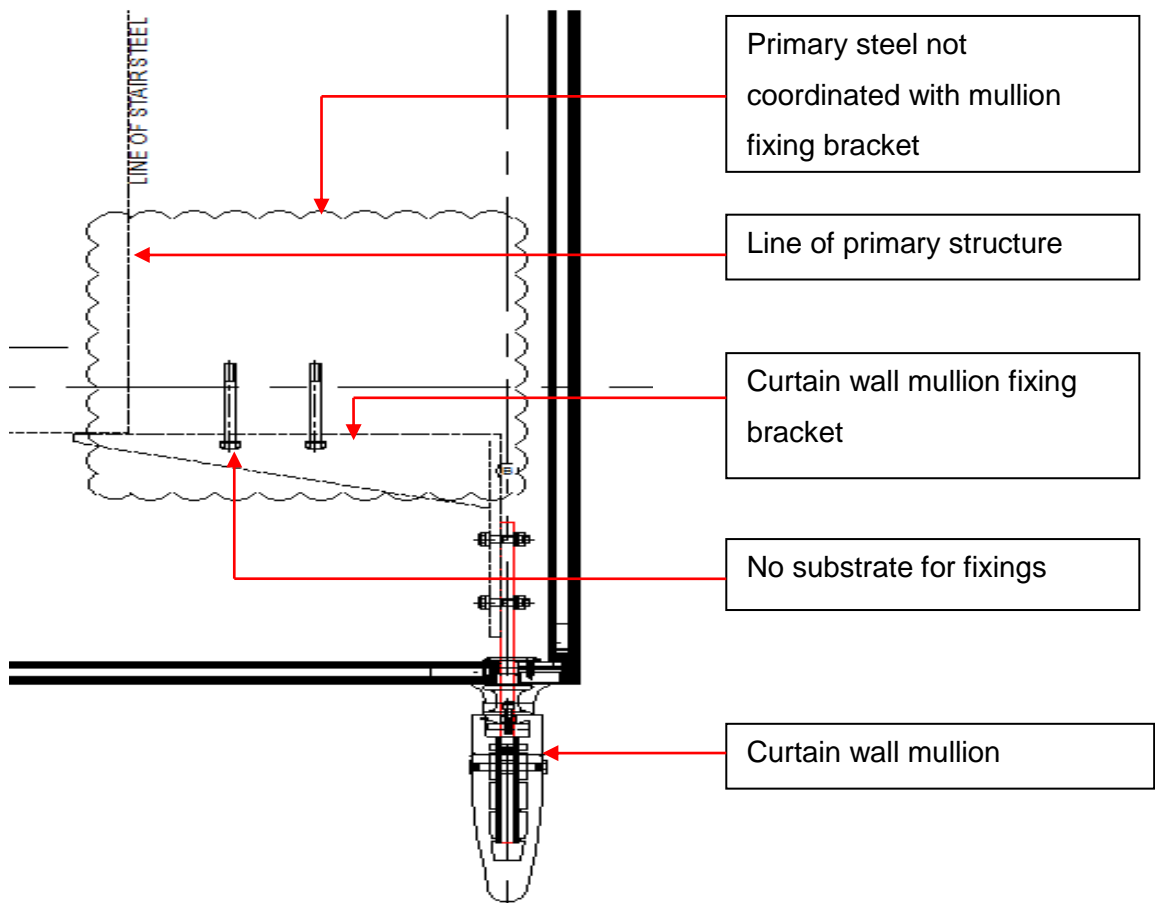
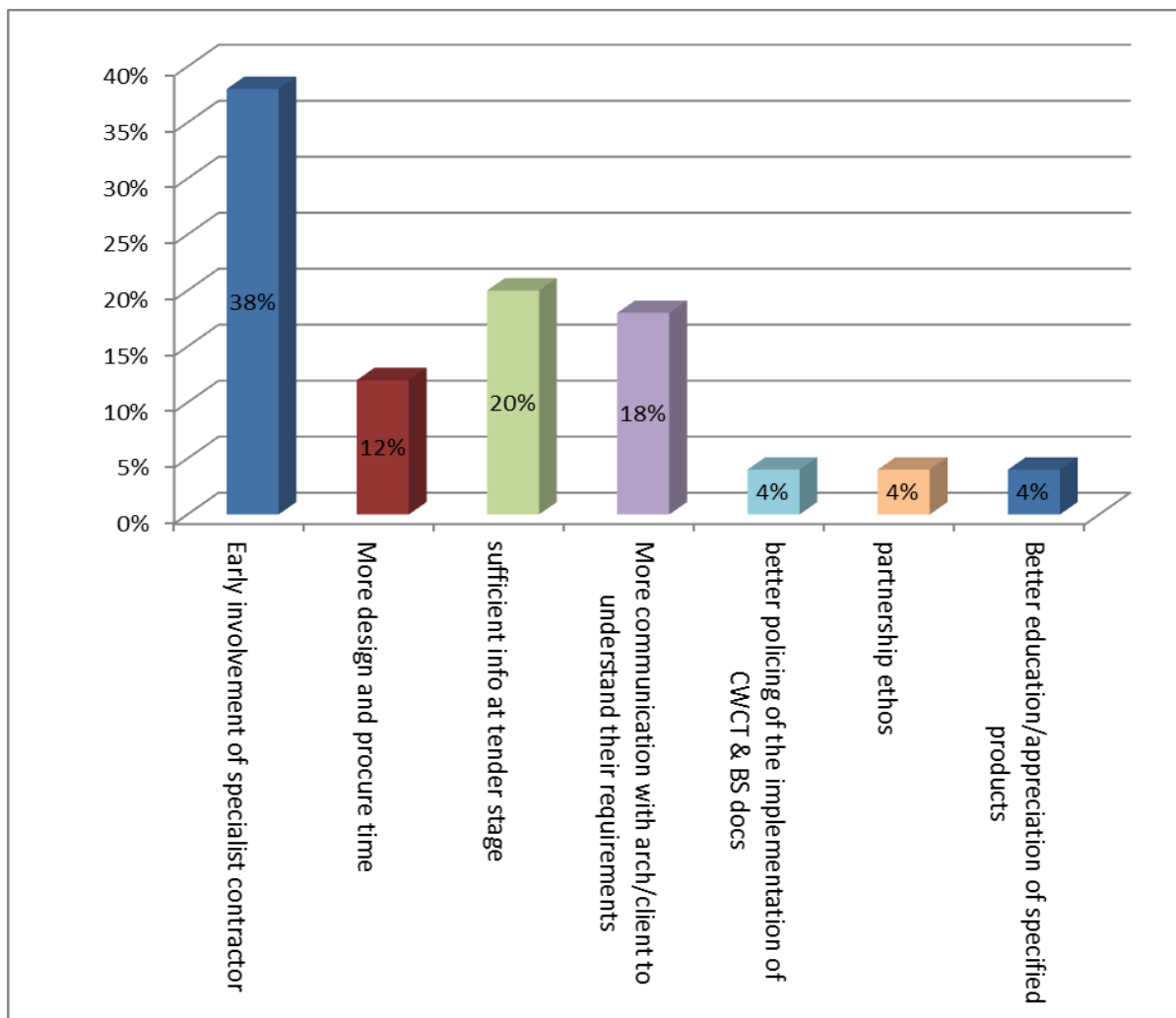


Figure 2.16: Example of facade coordination error –plan view.

A survey was conducted in March 2013 to provide a snapshot of the views of people within the construction industry and their attitude towards reducing risk associated with project delivery (figure-2.17). The results of this can be related to the comments made during an Interview (reaping the Benefits of BIM) with David Philp (2013) with regards to BIM promoting earlier engagement of contractors, 38% of the 50 respondents' claim that early involvement of the specialist contractor is the key factor to help reduce risk, speed up construction, reduce cost and provide better value. If BIM is promoting early appointment of specialist contracts then this can also be seen as a key benefit for the construction industry.



**Figure 2.17:** Reducing risk survey, Birrell, (2013)

It is anticipated that the various benefits described and illustrated above will increase the level of efficiency during the construction life cycle, and have the potential to reduce waste in terms of time and materials, provide better project outcomes, enhance building

performance and will optimise the approach to project delivery. However before these benefits can be acquired, the issues and barriers that surround BIM need to be addressed. Chapter 2.7 summarises this further.

## 2.7 Issues and barriers of BIM

BIM is set to change the way we operate both internally and externally throughout the construction lifecycle. The 3 main barriers of BIM implementation are described by Knight A, (2013):

1. **Expertise:** As BIM is a new development, there is not a great deal of expertise on the processes and technology can be difficult to grasp.
2. **Software Cost:** BIM is a new process so the anticipated benefits and potential cost saving have not yet been fully realised, therefore investing huge sums of money in BIM enabled software can be a turn-off for businesses.
3. **Workflow control:** Controlling the BIM work flow and input of information from multiple parties into the 3D environment can be a difficult task therefore protocol and set processes are important.

In summary, the main issues are related to cost, understanding processes and protocol, and lack of expertise. Due to this it is expected that façade contractors will face the J-curve when adopting BIM as illustrated in figure 2.18 which may present cost implications and potential risk.

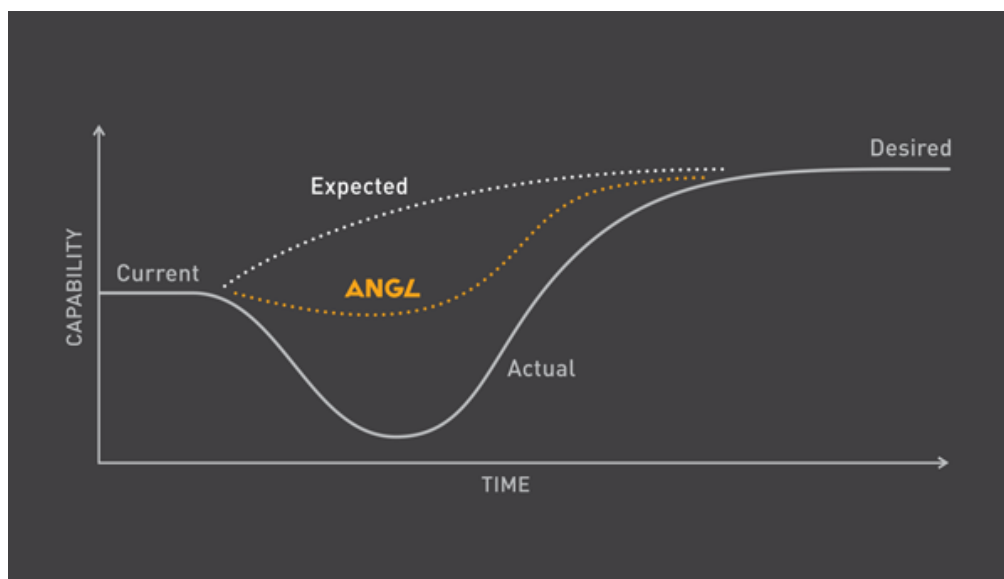


Figure 2.18: The BIM adoption J Curve, ANGL (2014)

Once people in the industry start to release the benefits of BIM and how it could potentially improve project delivery, it is perceived that willingness to adopt BIM will increase and people will start to commit to this change.

It is easier for large organisations to develop and implement a plan to adopt BIM as they have more resources compared to smaller companies. The BIM adoption survey in chapter 3.3 highlights that there are very few façade contractors dedicating staff to BIM mainly due to the key barriers described above and the general lack of understanding; it is more architectural practices that are dedicating the most staff as they have recognised that BIM is the top way to improve their ROI.

The cost of training and BIM software especially for small businesses is a potential stumbling block as they need to be confident that a ROI will be received. BIM enabled software is arguably one of the most important links in the BIM chain as most of recognised benefits and the key processes for BIM revolve around the 3D model. Chapter 2.8 examines the utilisation of BIM software in further detail.

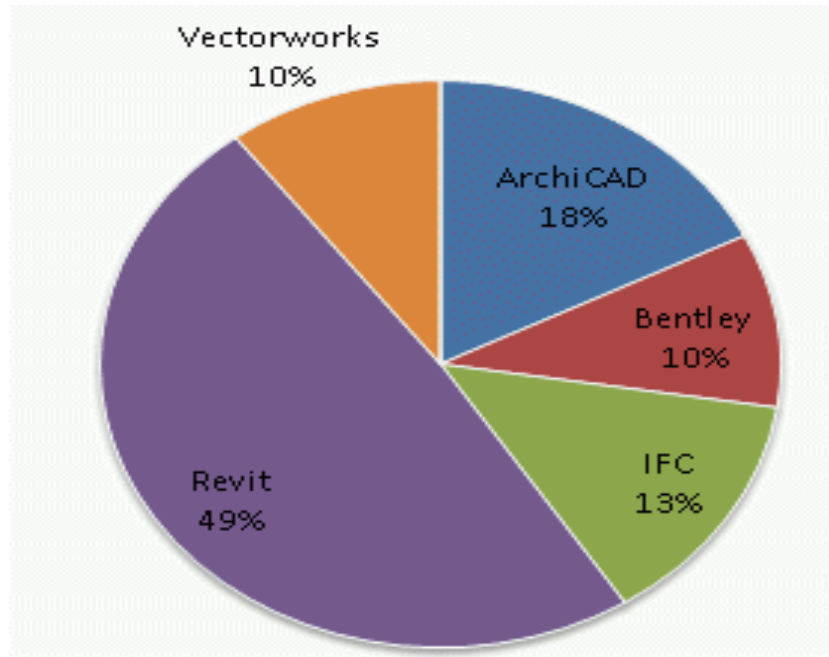
## **2.8 BIM enabled software**

The process of BIM heavily relies on 3D software which provides an information rich environment complete with a central database for the all of the project information which should be populated and maintained throughout the design process. There are various BIM platforms available which all have unique features for different uses, façade contractors need to consider which one is the most appropriate considering:

- Functionality
- Cost
- Interoperability
- Support/training
- Appropriate for façade interfaces and components
- Levels of detail

A survey highlighting the BIM tool market share (figure-2.19) and the findings from the survey in chapter 3.3 confirms that the most popular software in the AEC industry is Autodesk Revit.





**Figure 2.19:** BIM tool market share, Hamil S, (2013)

Autodesk Revit is a BIM application which enables architects, engineers, designers and contractors to create a virtual building using intelligent 3D components in a single model as a central project database. Revit can be used throughout the construction lifecycle starting from early concept design through to construction and later facilities management and demolition. It has the ability to allow every building element to be coordinated and allows users to instantly see the results of any design development or changes providing better grounds for decision making during the various stages in the building's lifecycle. As the model is progressed virtually, data can be extracted from the model such as 2D elevations, sections, schedules, it can also be used for 3D perspectives renderings and walkthrough animation.

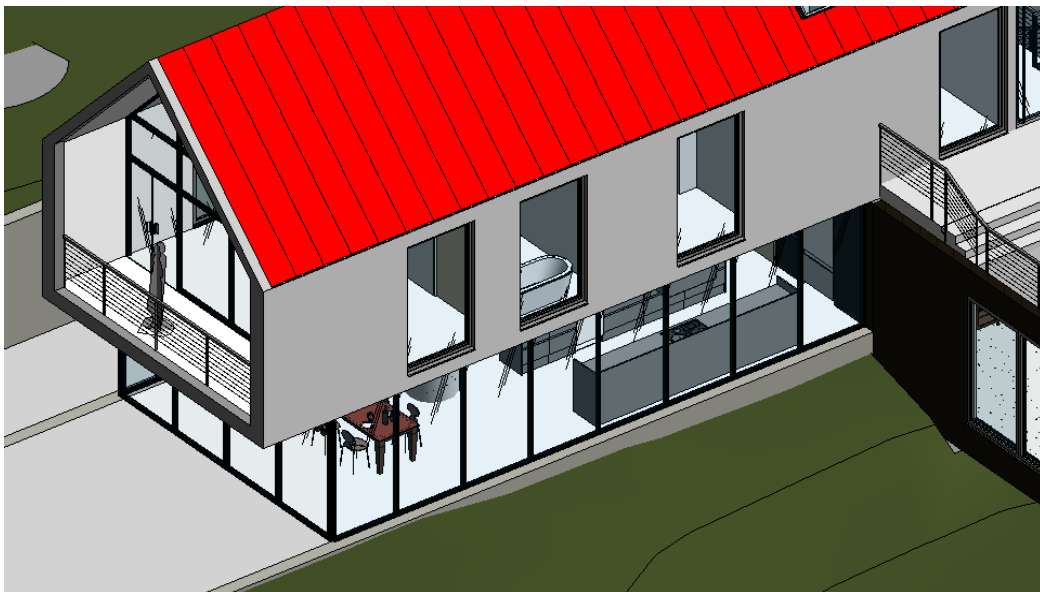
BIM is poised to be a major innovation in architecture industry in the 21st century and Revit supplies oxygen to this wonderful innovation (Architectural evangelist, nd.). In many sources it is suggested that the comprehensive features and functions of Revit provide an ideal solution for the implementation of BIM, however it is also claimed that the integration of Revit is a steep learning curve and remains as the main obstacle for BIM adoption in the construction industry.



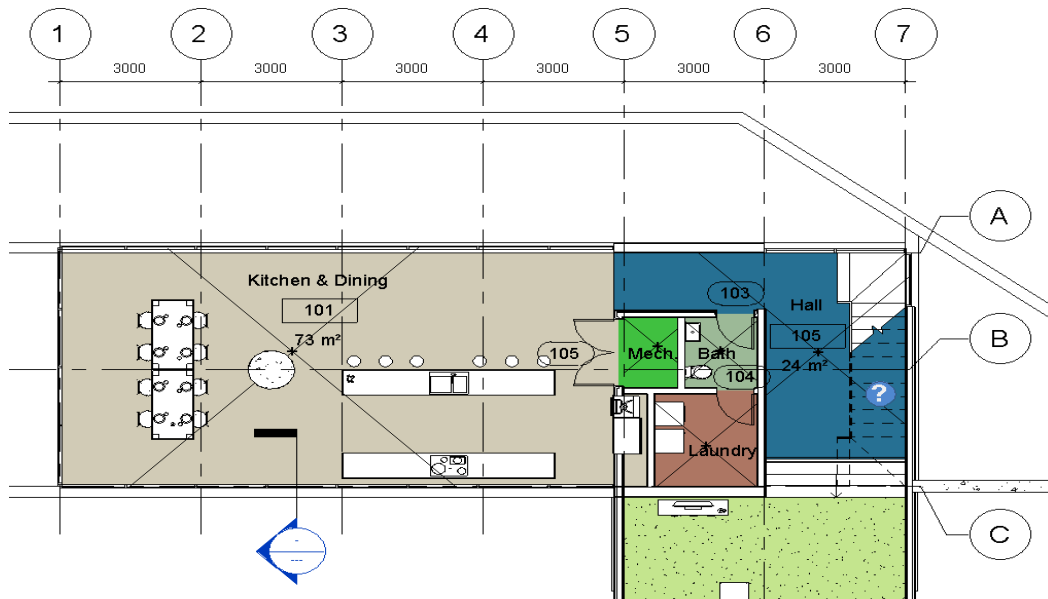
**Figure 2.20:** REVIT rendering, (2014)

In the context of façade design, questions have been raised with regards to the suitability of Revit for façade contractors as Revit is perceived to be more for conceptual design, renderings, and 3D visuals. The remainder of the chapter provides a brief introduction to Revit which includes a step by step analysis of the generated level of detail in Revit for façade interfaces.

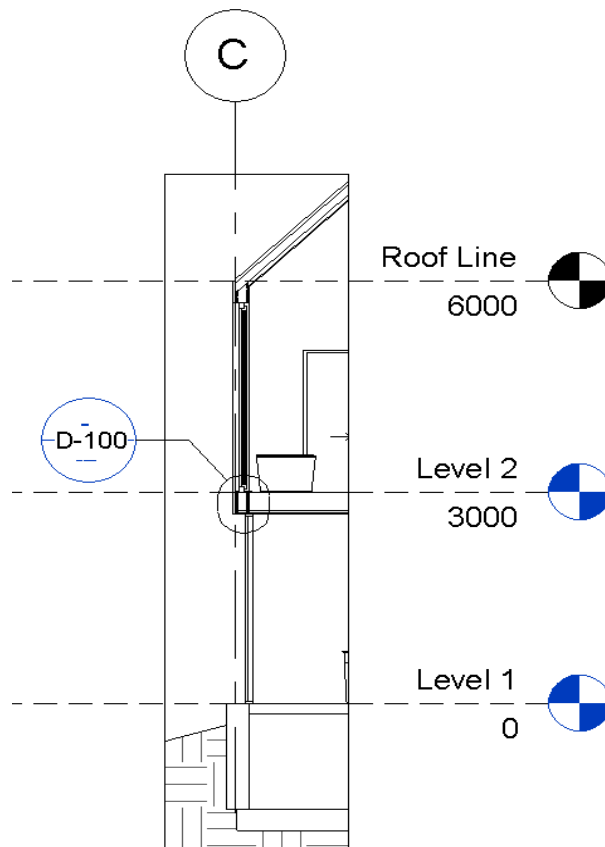
### **STEP 1: 3D model view**



**STEP 2: Change to plan view - generate a section view through glazing on gridline C**



**STEP 3: Call off 1:1 scale detail (D-100) from building section**

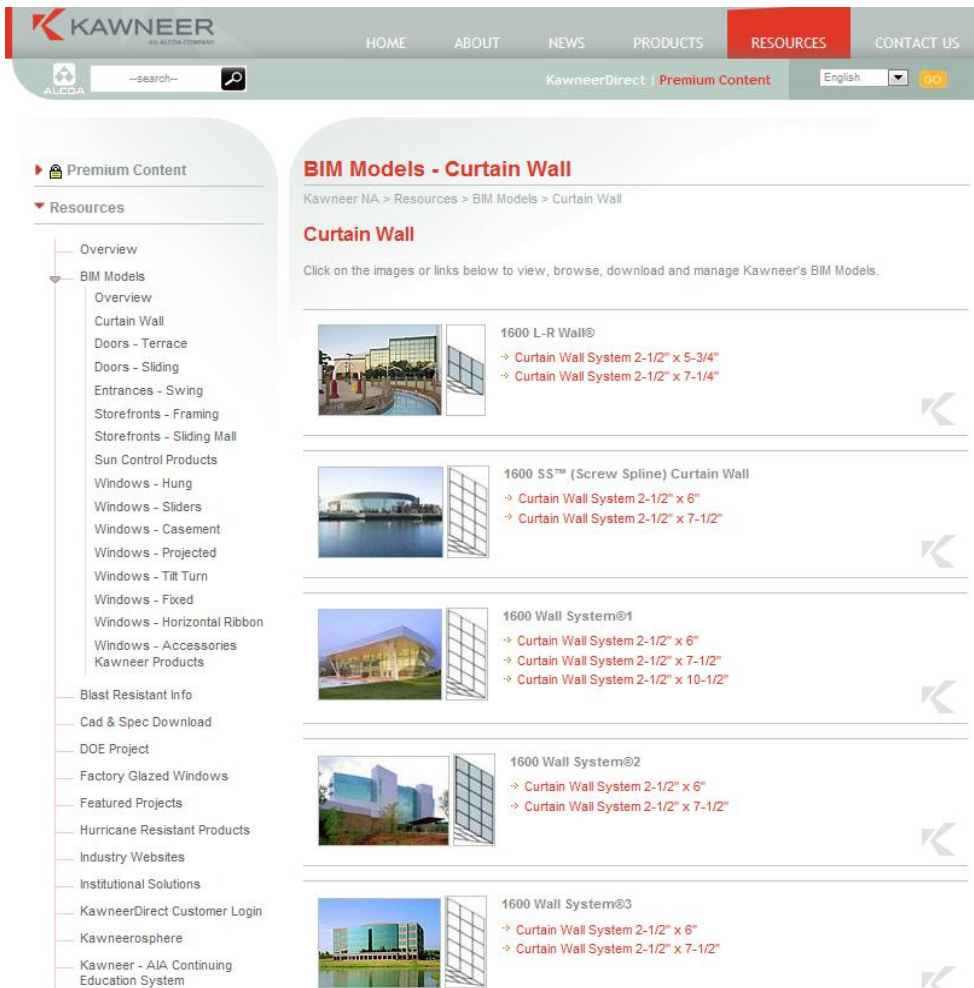




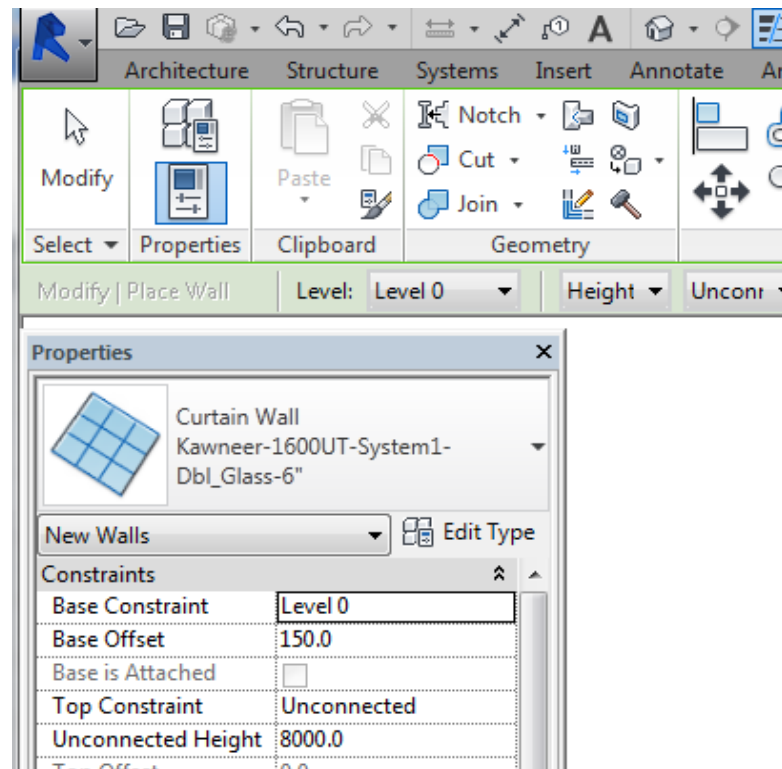
System suppliers such as Kawneer and Schuco have created BIM product models in order to help the design community when utilising BIM. These BIM product files contain families of façade components grouped together which can be imported directly into Revit and applied to the building façade in the 3D model.

A test was carried out utilising the online BIM product files in order to investigate the level of detail provided when these files were uploaded into a working Revit model. For this exercise, the files were downloaded from the kawneer website which offers BIM models specifically for the design community. The workflow of this test is illustrated below:

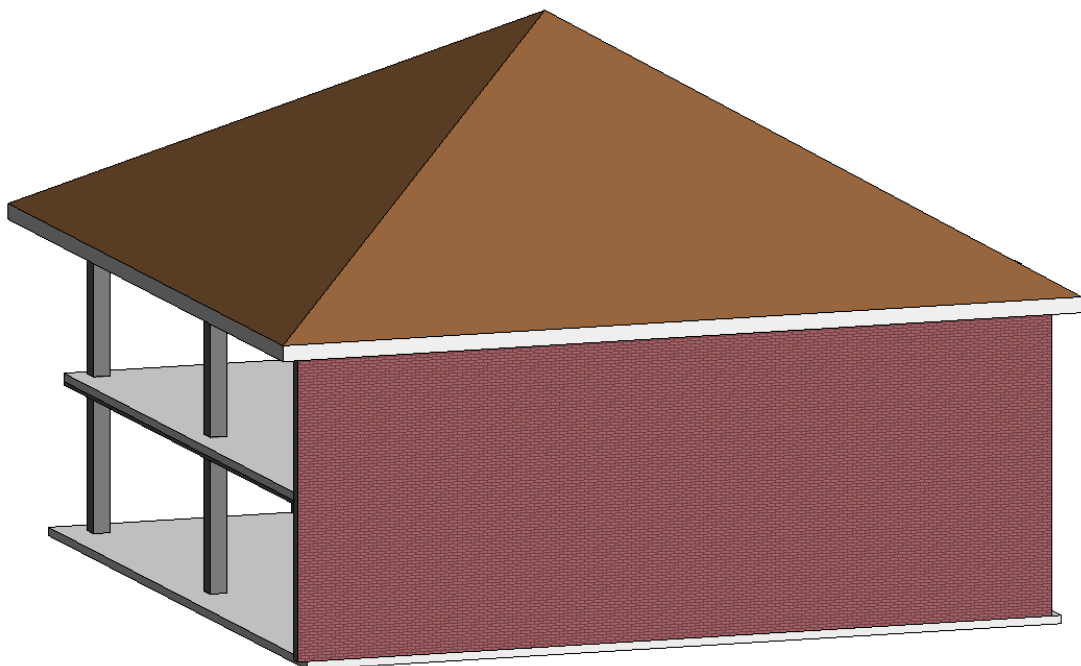
### STEP 1: Download BIM curtain wall product files



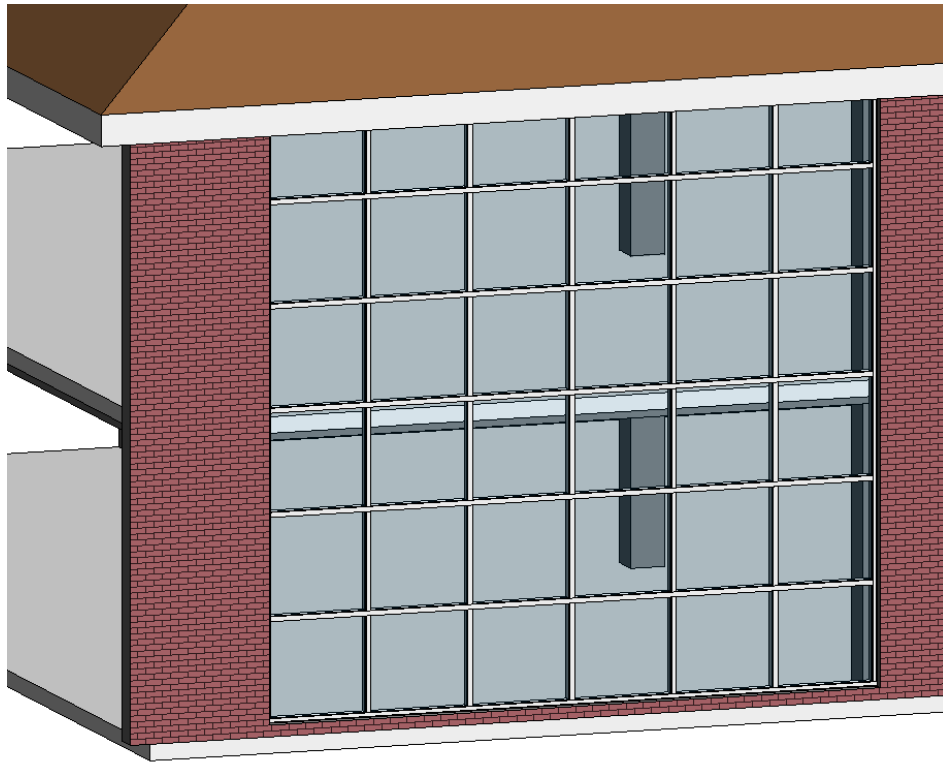
**STEP 2: Curtain wall product group imported into Revit**



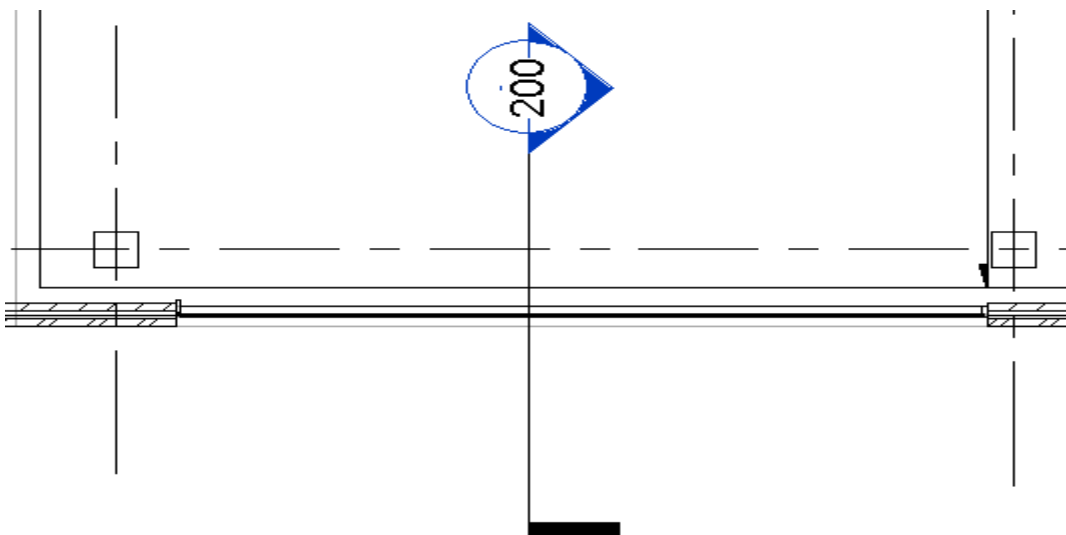
**STEP 3: Basic building façade created in Revit model.**



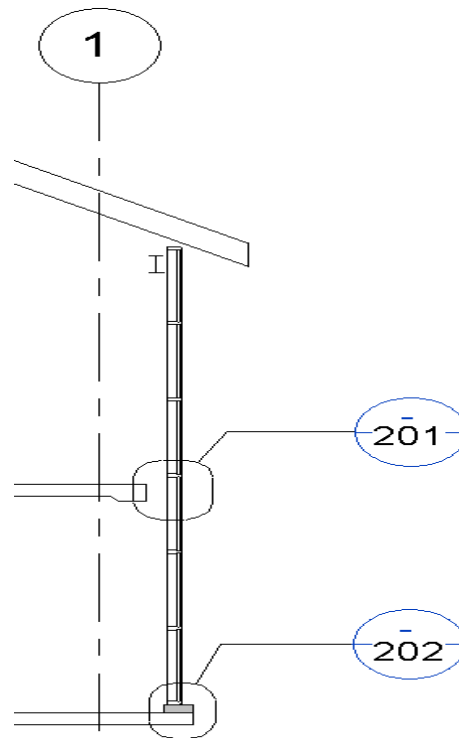
**STEP 4: Curtain wall system applied to façade.**



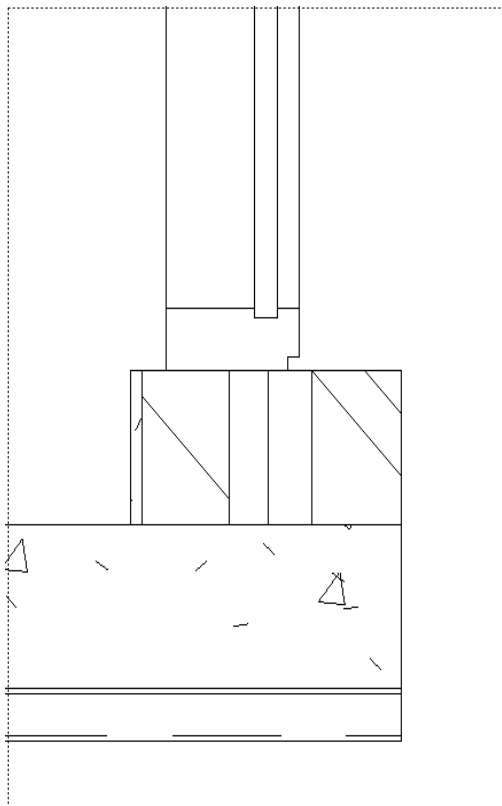
**STEP 5: Switch to plan view and generate section through curtain wall.**



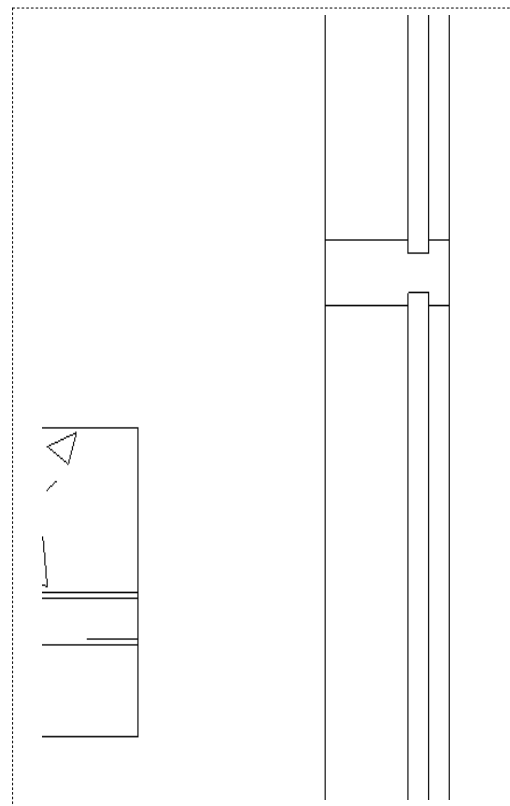
**STEP 6: Generate details from building section**



**STEP 7: Level of detail generated for curtain wall**



**Detail -202**



**Detail- 201**



In comparison to the detail in figure-2.21, the details generated in Revit using the BIM product files are still at a low level in terms of detail.

A key consideration for the utilisation of BIM is defining the appropriate level of detail for the 3D environment. While potential benefits of utilizing such models are much talked about there have not been many research studies investigating the modelling effort associated with generating BIM at different levels of detail and the impact of an LOD in a project. Such evaluations are needed in order to take full advantage of the benefits of a semantically-rich building representation (Leite F et al 2011).

Façade contractors generally produce the level of detail shown in Fig-2.21 incorporating extrusion lines, dimensions, brackets and fixings in order to clearly show the installers how the curtain wall is to be constructed on site, furthermore, detail drawings are used for other purposes such as:

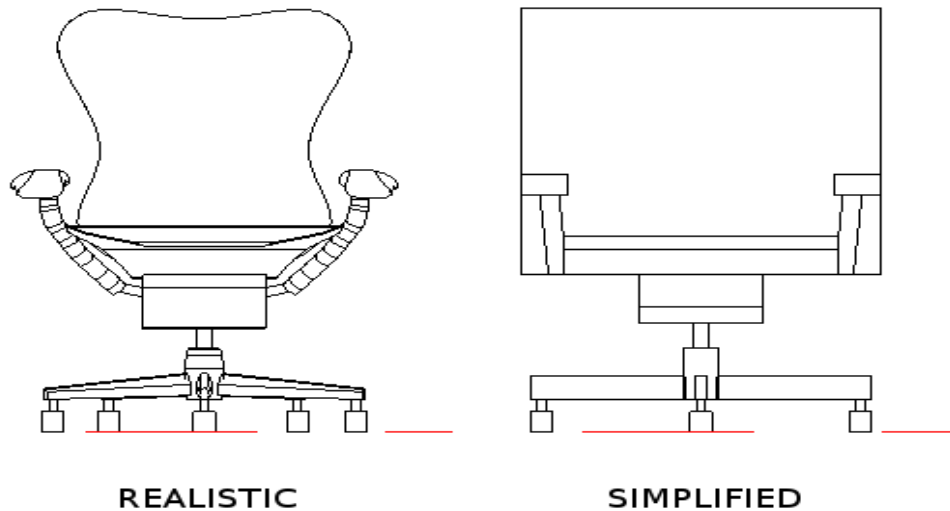
- Manufacture and procurement
- Achieving appropriate Weathertightness
- Ensuring thermal requirements are achieved
- Ensuring fire and acoustic requirements are achieved
- Structural calculations on brackets, fixings etc.
- Scheduling façade components

Further investigation is required to establish if Revit is capable of modelling higher levels of detail, also the practicalities and the time involved in doing so. The more lines and detail that are added to the model the harder Revit will have to work; also high levels of detail will increase the size of the model making it difficult to operate. Software firm D/C/CAD (2009) expands further on this issue and suggests that product manufactures are responding to industry demands by creating product families to coincide with BIM software, however they tend to contain excessive detail which can significantly increase model size and slow things down.

*“Don’t over-model. One of the most common mistakes among new users of Revit is to put too much detail in the model. Determine how much detail is really necessary to convey your design intent, and then monitor your team to prevent over-modelling”.*  
(D/C/CAD, 2009)

An example of over modelling and the effects is described by Mcphee A (2012):

*“The realistic model file was 2.7 times the size of the simplified model file. When there are 10 chairs it goes to 4.5 times larger and the time to process the realistic model file was noticeably longer”* Mcphee A (2012).



**Figure 2.22:** Over modelling example, Mcphee A (2012)

Façade design details consist of many lines that provide the finite detail for extrusions, gaskets, brackets, fixings etc. however in light of the above, this level of detail is likely to cause functional issues with the software. With the above in mind, further research is undertaken in chapter 4.2 which includes a technique of achieving greater levels of detail in the BIM environment considering the associated problems with over-modelling.

## 2.9 Summary of literature review

In many sources, it is suggested that the main problems with regards to BIM adoption is the lack of concrete understanding of what BIM actually is. This lack of understanding affects the ability for organisations to engage in forward planning, it also inhibits them from investing time and money into BIM in terms training staff new processes/workflows and investing in BIM enabled software. It is suggested by Connaughton J (2012) that the approach to design and construction is set to fundamentally change how people approach their discipline; however it is argued that most companies will reproduce current workflows which in general terms should not change for the implementation of BIM to any great degree, the only fundamental changes will be the switch to 3D software and incorporating BIM standards.

There is clearly a knowledge gap when it comes to BIM software in terms of understanding the capabilities and limitations of BIM technology. It is also suggested that there is not a huge amount of BIM expertise in the industry and BIM software can be complicated and difficult to grasp hence the reluctance to take on BIM.

There are a number of statements that suggest that BIM will provide better collaboration, improve efficiency, reduction of waste/time, and adding value to the project life cycle. The key thing is to understand how to successfully implement BIM considering new processes, BIM standards, and how to utilise BIM software.

Considering the findings from the literature review and the objectives of this paper, a methodology was devised which consisted of a BIM workshop, 2 email surveys and an interview with a director from a leading architectural practice. The key aims of the methodology was help gain underlying knowledge with regards to the views and opinions of BIM in the construction/façade industry, and to gain a better understanding with regards to BIM enabled software, BIM implementation in terms of adoption levels and commitment, and to provide an insight on the key considerations for successful BIM implementation.

As this research is driven by the needs of the façade industry, it was important to understand the current adoption levels in this sector alone and their views and attitudes towards BIM. In order to establish this, a façade supply chain meeting took place which was attended by 13 of the major façade contractors who operate in the UK. All of the façade contractors in attendance were large organisations where BIM implementation is high on their agenda. To get 13 of the top façade contractors in the UK in the same room at the same time to openly discuss their opinions and thoughts on BIM is a rarity to say the least, the results of this are shown in chapter 3.1 which determines current adoption levels in the façade industry, and summarises the key issues that were raised in relation to BIM.

In order to gather the views of the construction industry from a relatively large number of respondents, an interactive web survey was carried out to establish the following:

- Current adoption levels in the construction industry
- General understanding of BIM
- Most commonly used software and functions
- BIM dedication and investment

Objective 3 of this research was to understand the main issues and barriers of BIM adoption in the construction industry. The industry wide survey included an open ended question '*what do you think is the key to successful BIM implementation?*' which was linked to this objective. Research carried out in this way produces descriptive data such as peoples own spoken or written words or observable behaviour (Naoum S, 1998). The results of this are shown in chapter 3.3.

The web survey was aimed to target the general population of the construction industry (not specific to the façade industry) and was believed to be the most appropriate method in order to gather a range of responses in a short time frame. A key consideration for the web survey was to keep it short as people in the construction industry tend not to have time to be filling out surveys, therefore the survey were designed to take approximately 2 minutes to complete to help maximise the number of respondents.

There are clear knowledge gaps associated with BIM software, therefore further research was required to analyse the limitations and capabilities in conjunction with façade design. Before commencement of this analysis, the appropriate level of detailed for the BIM environment needed to be established. An email survey was selected for this to help target a specific group of people, the survey was issued to the same 13 façade contractors who attended the Mace façade supply chain to help maintain consistency in terms of company size, experience and level of BIM interest. The results of this are shown in chapter 3.2 which also concluded objective 4 of this research.

It is anticipated that BIM adoption in the façade industry is at a low level, therefore the question to establish the most commonly used BIM software was issued as part of the industry wide survey in chapter 3.2 to help gain a wider range of responses.

As architectural practices seem to be leading the way for BIM implementation, a face to face interview was arranged with John Orrell director of DLA architects which took place in May 2014. An exploratory interview approach was taken as the interview was carried out at the beginning of this research; an unstructured approach was taken with general level questions to allow the interviewee to control the direction of the interview. Using this method, it was important to provide the interviewee with a clear research outline. The interview provided an opportunity to gain some knowledge with regards to the BIM workflow, key considerations for implementation and the benefits being experienced, as DLA use BIM enabled software on a regular basis, it was also was a good opportunity to discuss the functions, uses, and capabilities of the software. The information gained from these discussions also contributed towards objective 5 of this research.

### 3 Methods and results

#### 3.1 Mace façade supply chain and BIM workshop

Mace group are industry leading consultancy and Construction Company based in London offering fully integrated services for the construction life cycle. The implementations of BIM is high on their agenda, and have a strong believe in collaborative working which fits with the working practices of BIM.




On the 09<sup>th</sup> May 2014, Mace held a façade supply chain meeting to discuss the concept of BIM and to outline how Mace are preparing to adopt BIM prior to the 2016 directive. The BIM presentation was conducted by David Hammond (BIM champion Mace) and Philip Sedge (Mace facade director). The following façade groups/contractors were in attendance:

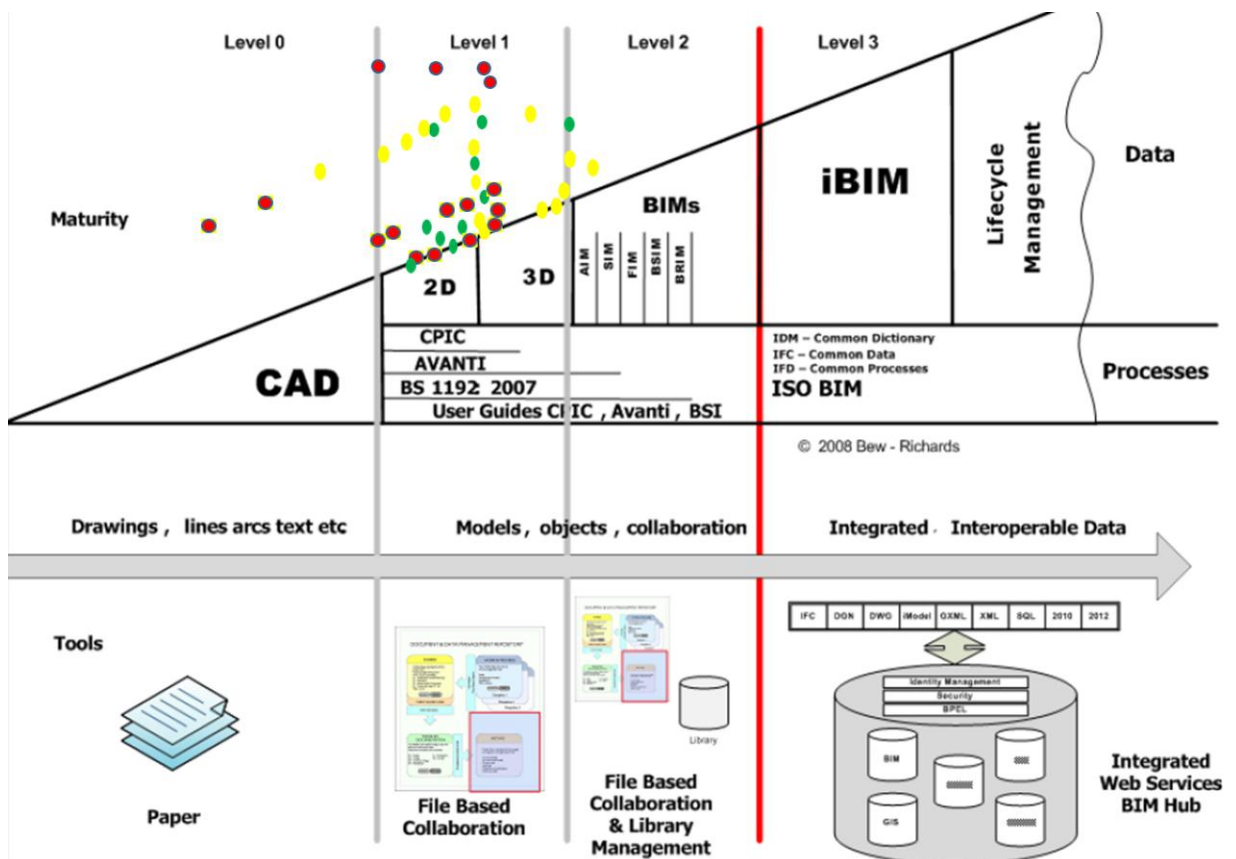
- Glassolutions –Saint-Gobain
- Permasteelisa
- Focchi
- Lindner Schmidlin
- Yuanda
- Prater
- Dane Architectural
- Lakesmere
- Fendor
- GIG
- Fleetwood
- Colorminium group
- Far East Facade UK Ltd

During the presentation, open discussions were encouraged between the key façade supply chain members in order to help Mace understand the progress of BIM implementation amongst their façade supply chain. All of the façade groups listed above confirmed that they have plans to implement BIM within their business in the near future,

and are actively looking to invest further in training in order to increase the level of BIM competence within their business. Attendees were asked to take part in a workshop poll to establish the general consensus of the level of BIM adoption in the construction and curtain wall industry. The exercise consisted of applying a coloured sticker to the BIM maturity wedge in the most appropriate section; the results of this are shown in figure 3.1.

**Colour key:**

-  - Where is the cladding and curtain wall industry?
-  - Where is the construction industry in general?
-  - Where are you now?



**Figure 3.1:** Mace façade supply chain poll, (2014)

During the open discussions, there were many key points raised in relation to BIM adoption and achieving level 2 BIM which are shown in appendix 1, the following 4 points were the most common issues and concerns raised:

- Contractors are normally appointed too late, early appointment is required for BIM.
- How will the design review and approval process work for BIM?
- Revit is not sophisticated enough to accommodate the level of detail for facade components and building interfaces.
- Lack of understanding of BIM in terms of the approach to the design process, contractual requirements and procurements routes.

### **3.2 Email survey – appropriate levels of detail for BIM**

To establish the appropriate LOD (Level of Detail/Development) for façade design when implementing BIM, an email survey was issued in June 2014 to the same 13 façade contractors who attended the Mace façade/BIM workshop. All were all from large organisations with BIM implementation high on their agenda, and were considered to be relatively experienced in façade design and detailing therefore consistent results were expected.

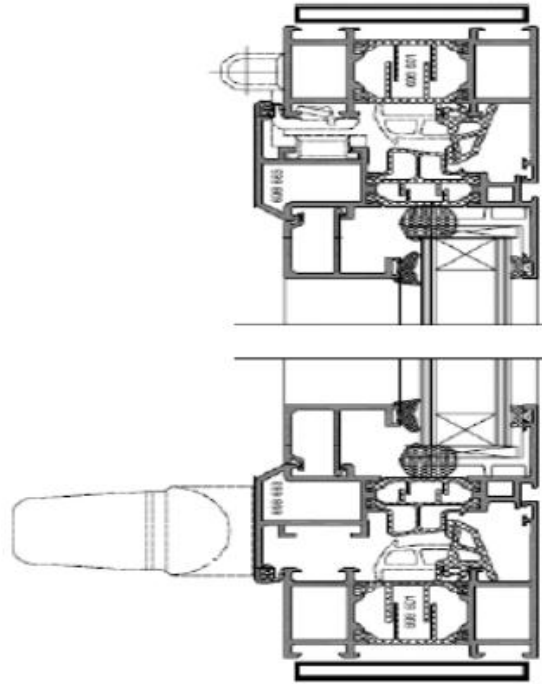
The survey provided respondents with a series of window and curtain wall section details comprising different LOD, respondents were asked to select the most appropriate LOD for the BIM environment. Out of the 13 email surveys issued only 5 responses were received, however as the results of the survey were relatively consistent , the low level of responses received were considered to be sufficient to conclude the aim of the survey.

The façade contractors who provided a response to the survey were:

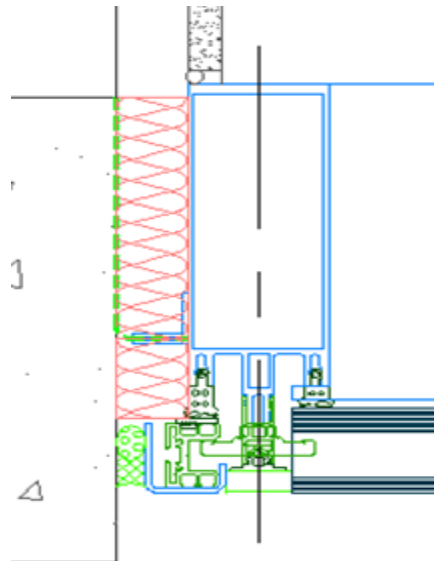
- Far East Facade UK Ltd
- GIG facades
- Glassolutions
- Fendor Ltd
- Fleetwood Architectural aluminium

4 out of the 5 façade contractors selected the high resolution window detail as shown in figure-3.2, for the curtain wall detail, 4 out of 5 respondents choose the stage 3 detail level as shown in figure-3.3.

The high resolution detail selected for windows included system components, glazing configuration gaskets and extrusions, which is generally the level of detail used for the traditional 2D design process. With regards to the curtain wall selection, this comprised of a tolerance gap between the mullion/structure, EPDM membrane, extrusion profiles, gaskets and glazing configuration.



**Figure 3.2:** High resolution widow detail



**Figure 3.3:** Stage 3 curtain wall detail



2 open ended questions were included as part of the survey, open ended questions have the advantage of giving an opportunity to respondents to express their views on the subject (Naoum S, 1998). Both questions are linked to objective 3 of this research which was to gain an insight to the barriers of BIM adoption.

**Q1: Do you think BIM software is appropriate for façade design?**

Summary of comments:

- BIM software is appropriate for façade design but data and complexity should be kept to a minimum.
- Complexity of the façade needs to be considered when using BIM software as it is not sophisticated enough to accommodate high levels of detail.

**Q2: What do you think is required the most to enable façade contractors to successfully adopt BIM?**

Summary of comments:

- Current project time scales are not set up for BIM and need to be changed.
- Low cost or free software should be provided.
- Clear examples of window and curtain wall systems should be established by façade contractors for 3D and 2D design.
- A clear BIM protocol is needed which should be provided by an independent body such as CWCT.

**3.3 Industry survey - current BIM adoption in the construction industry**

A survey was carried out in May 2014 which was directed at people who worked for architectural practices, main contractors and façade contractors. The purpose of the survey was to provide a conclusion to objective 2 of this research: *Examine the current adoption levels of BIM within the construction industry*, and to gain an understanding of:

- General level of BIM interest amongst clients
- Most commonly used BIM enabled software

- Primary functions of BIM software
- General awareness of BIM in the industry
- Keys to successful BIM implementation

The survey was created using an online survey programme called Smart Survey, the link to the interactive survey was sent via email to specific people in the construction industry with the key questions relating to BIM knowledge and implementation.

The aim of the first 5 questions were to gain a general understanding of the profile of the responders in terms of job role, age, years of experience and the number of people in their organisation. In total there were 40 respondents with a range of job roles which have been categorised into 3 distinct groups: architectural practices, main contractors and façade contractors.

Questions 6-7 were to establish the level of BIM interest within the construction industry, and if respondents intend to use it in the near future. Questions 8-10 were associated to the levels of BIM maturity people were able to produce, the most commonly used software in the industry, and the primary functions of BIM enabled software within their business. Questions 11-14 were to establish general awareness of BIM within the construction industry, adoption levels, and to understand which practices have plans in place to adopt BIM.

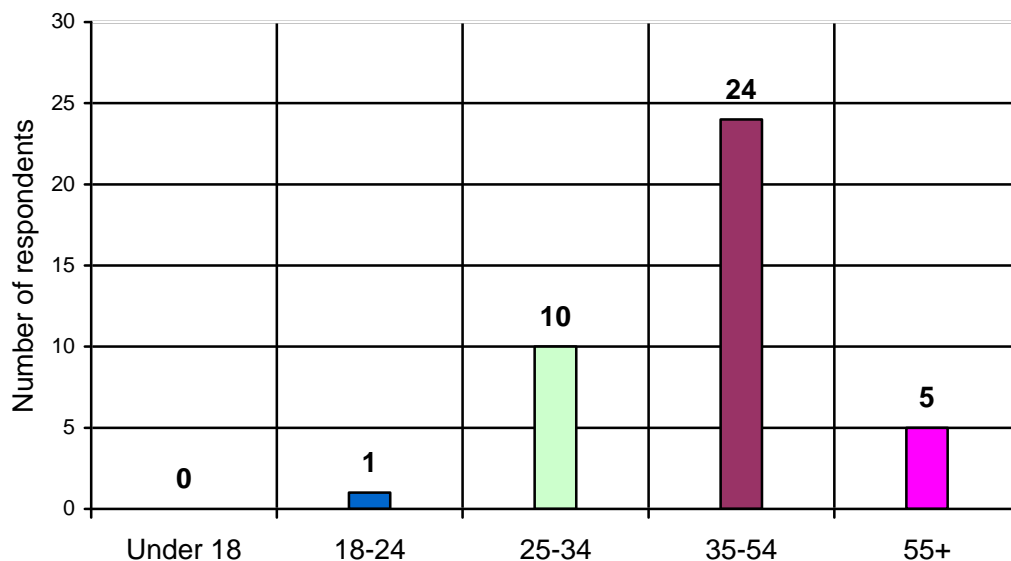
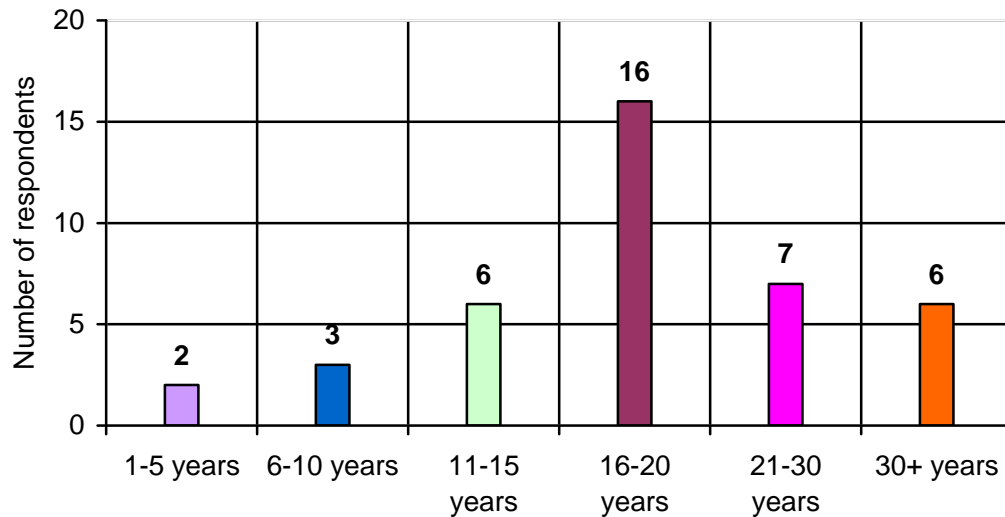
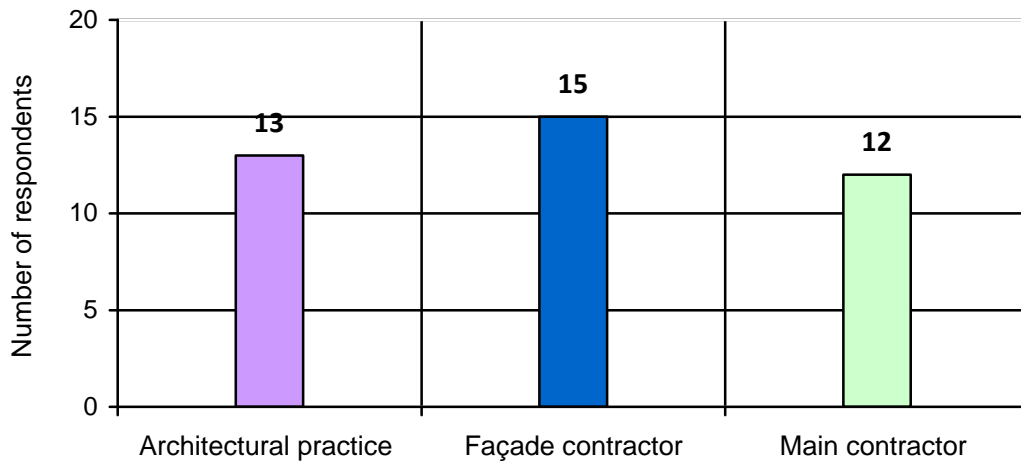


Figure 3.4: Ages of respondents

Figure 3.4 above shows that out of 40 respondents, 60% were between the ages of 35-54, none of the respondents were under the age of 18. In terms of years of experience, figure 3.5 below shows that the majority of respondents (40%) had between 16-20 years of experience within their field with only 5% having 1-5 years' experience. The results of this qualifies that the majority of respondents were over the age of 25 with at least 10 years working experience within their field.



**Figure 3.5:** Years of experience



**Figure 3.6:** Job category of respondents

Figure 3.6 above shows the distinct groups of the 40 respondents with 37.5% working for or on behalf of the façade contractor, 30% working for main contractors and 32.5%

working for architectural practices. This concludes that there is a relatively even range of respondents from each category.

Figure-3.7 below indicates that the majority of respondents (40%) worked for medium sized enterprises with between 51 and 250 employees, slightly behind this with 32.5% was respondents who worked for large enterprises with more than 250 employees. At the lower end of the scale with 12.5% were companies with 10 people or less, which were generally small sub-contract drawings offices working on behalf of the façade contractor.

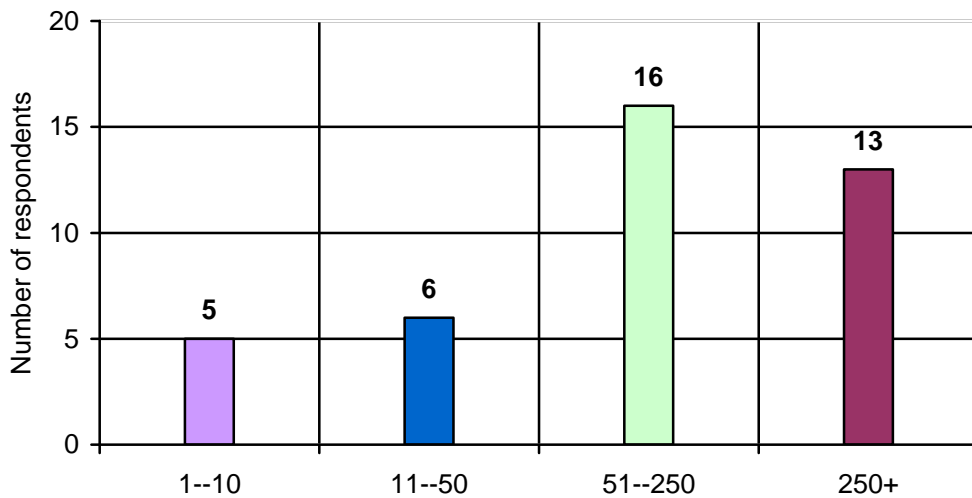


Figure 3.7: Number of people in organisation

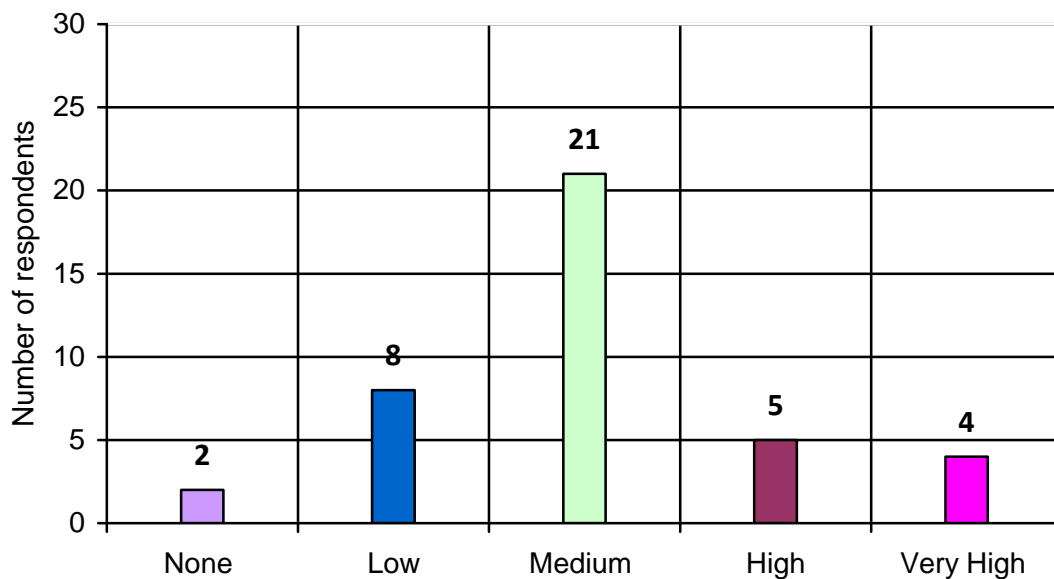
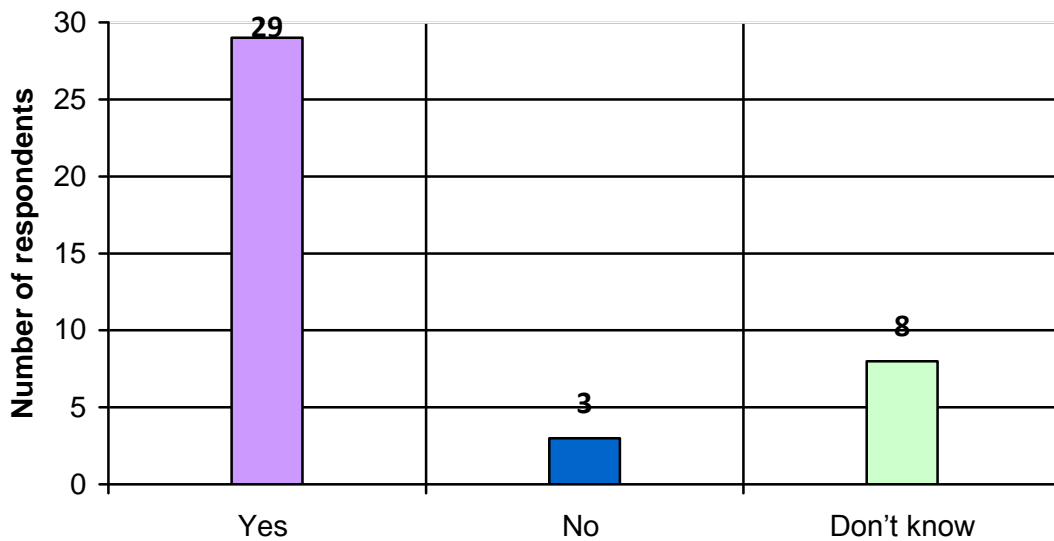


Figure 3.8: Level of interest of BIM amongst clients in you market place

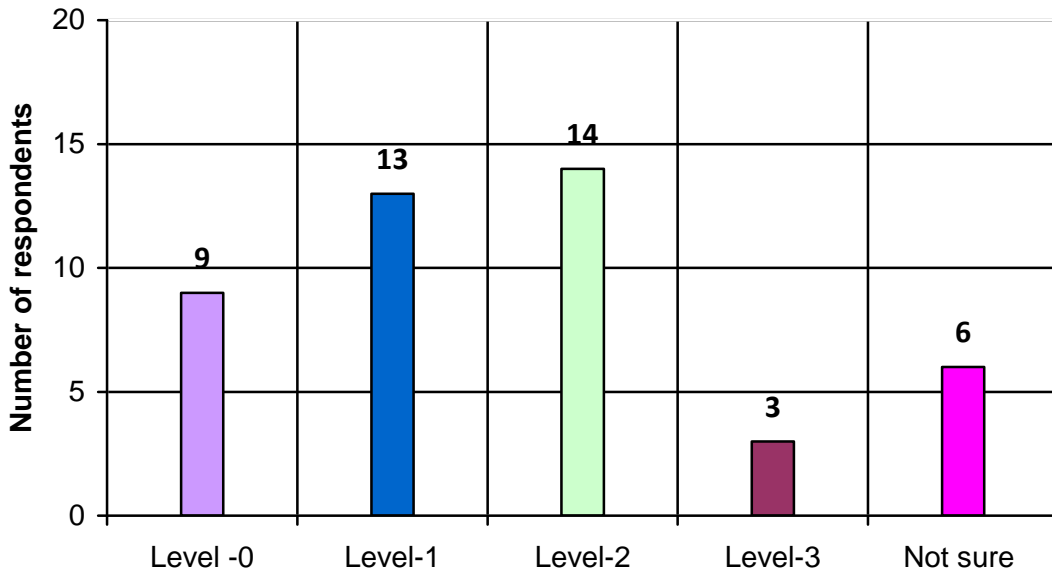
Figure 3.8 shows the level of interest amongst clients in the construction industry, 52.5% of responders claim that there is only a medium interest within their market place with only 10% claiming that there is a high level of interest.

Figure 3.9 below shows that 72.5% of respondents currently use BIM, or is intending to in the near future. The 20% and the 7.5% of respondents who were not intending to adopt BIM or did not know were mainly people who worked for small sub-contract drawings offices working on behalf of the façade contractor.



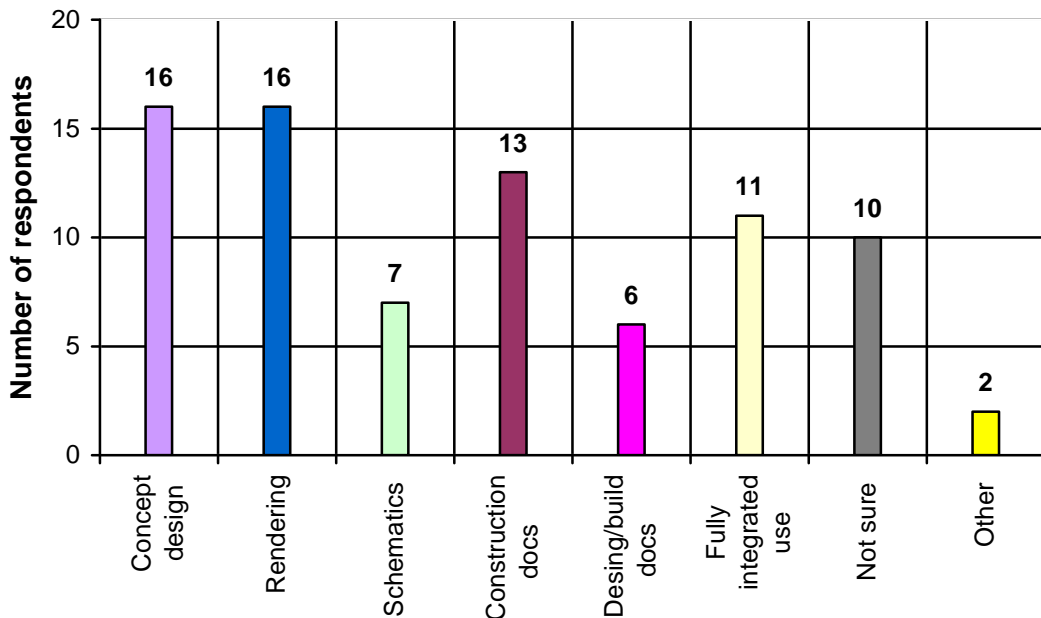
**Figure 3.9:** Do you currently use BIM or intending to use BIM in the near future?

Figure 3.10 below shows that 35% of respondents claimed that they were able to produce level 2 BIM, the 35% equated to 7 people working for architectural practices and the other 7 working for main contractors. 37% claim that they were either unsure or still at level 0. Responses from the façade supply chain were generally at level 0 to 1.



**Figure 3.10:** What level of BIM is your company able to produce?

Figure 3.11 is the results of a multiple choice question to determine the purpose and general usage of BIM software. The results show that BIM software is used for a range of purposes with concept design and renderings being the most common. 27.5% of respondents claim that they use BIM software for fully integrated use (level 2 BIM).



**Figure 3.11:** Primary function of BIM software

Question 10 was to establish which BIM software is the most commonly used within the industry. Figure 3.12 below show that 72.5% of respondents use Autodesk Revit for BIM projects. Behind this with 20% was Tekla, which is generally used for steel and structure design. The 35% who choose 'other' either stated that they were not sure or did not use any type of BIM software.

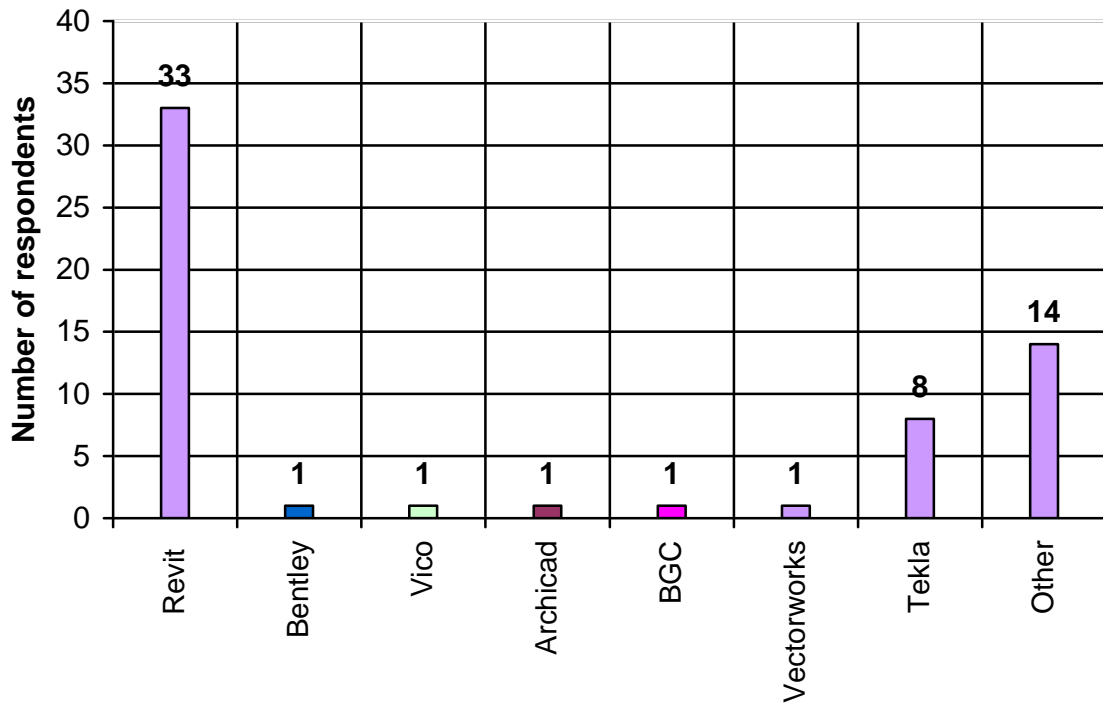
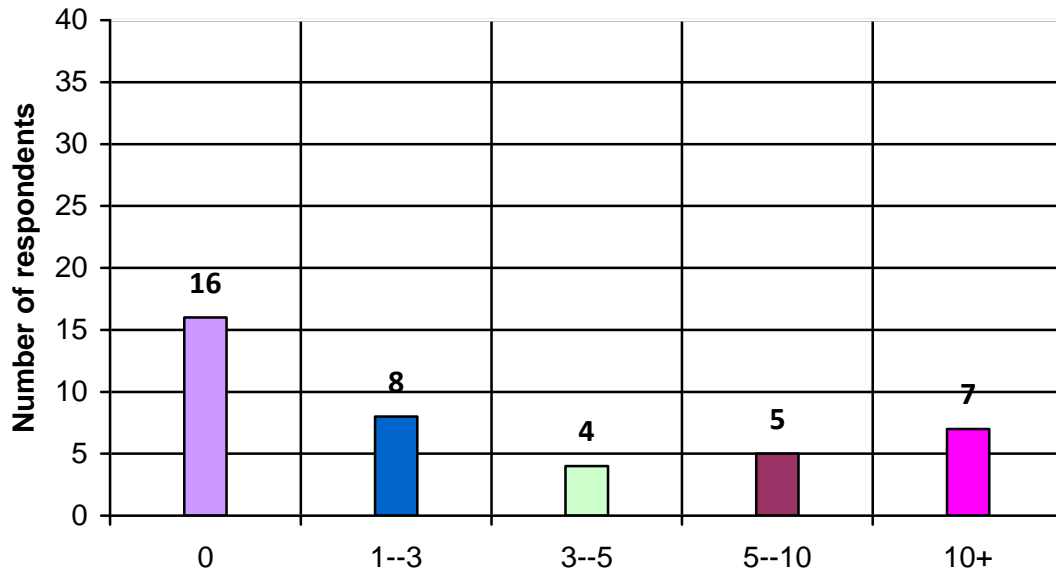


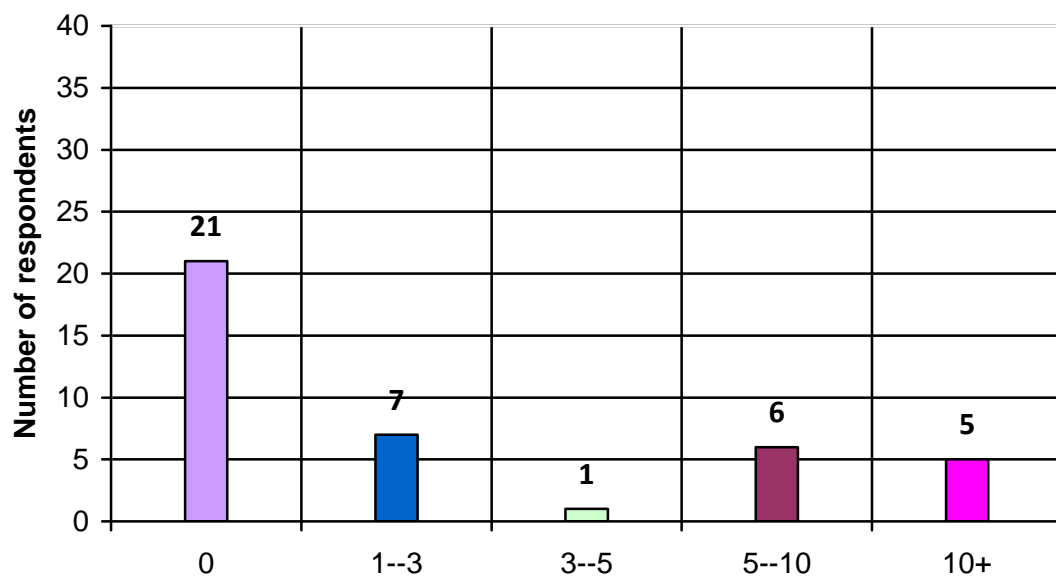
Figure 3.12: BIM enabled software used.

Figure 3.13 below shows the results to question 11 to establish which practices have the most people dedicated to BIM. Results show that 40% of respondents did not have any people dedicated to BIM within their company which was the most popular choice, 17.5% claim that they have at least 10 people or more dedicated to BIM, the vast majority of respondents who claimed this were from architectural practices.



**Figure 3.13:** Number of personnel dedicated to BIM.

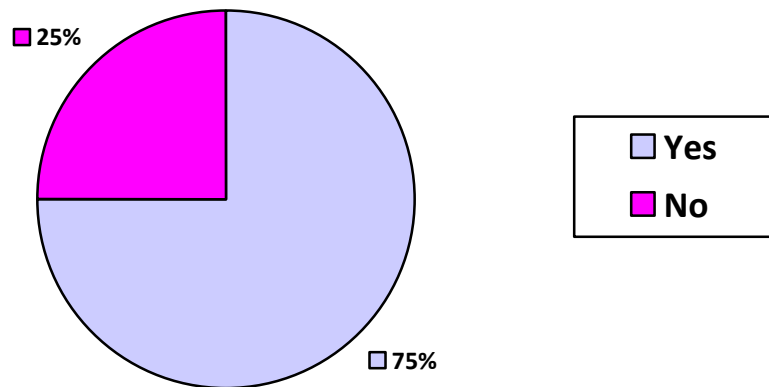
Figure 3.14 shows the results of question 12 which was to establish which practices in the industry have completed the most projects using BIM. The majority of respondents (52.5%) claim that they have not completed any projects using BIM, the 12.5% of people who have completed 10 or more projects were all from architectural practices, the majority of respondents who claimed to have completed between 5-10 projects were people working for main contractors. Respondents working for façade contractors had not completed any projects using BIM.



**Figure 3.14:** Number of projects completed using BIM.

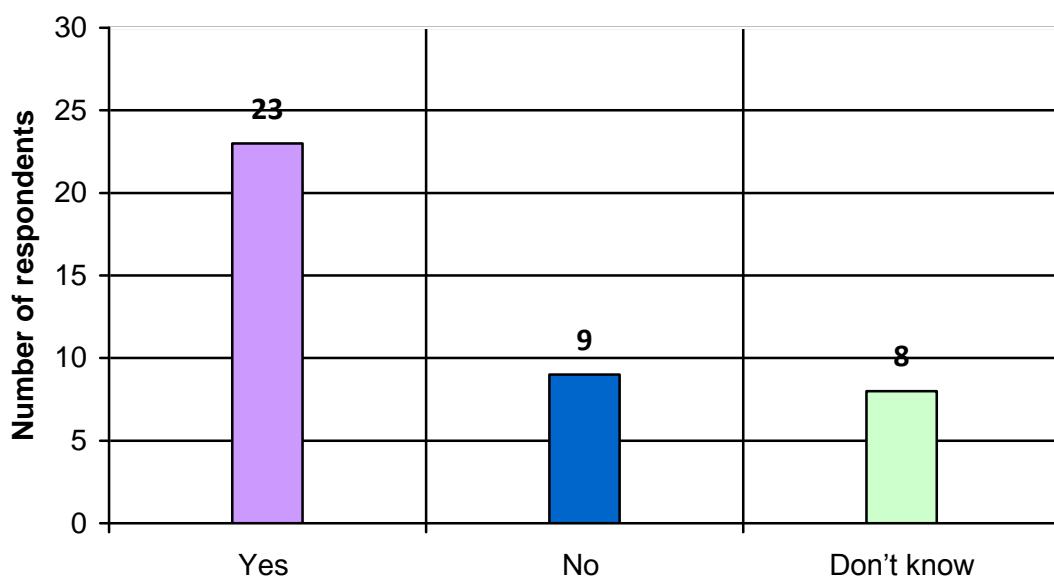


Question 13 was with regards to the awareness of the UK Government directive for the use of BIM on all public sector projects from 2016. 75% of respondents were aware of this; the 25% of respondents who were not aware were all from small sub-contract drawing offices working on behalf of the façade contractor.



**Figure 3.15:** Are you aware of the UK Government directive for BIM for 2016?

Question 14 was to establish if development plans had been established within the business for making the change to BIM. Figure 3.16 highlights that 57.5% of the respondents confirm that their company has a development plan in place, 22.5% confirmed that they have no plans in place and 20% were unsure.



**Figure 3.16:** Do you have development plan for making the change to BIM?

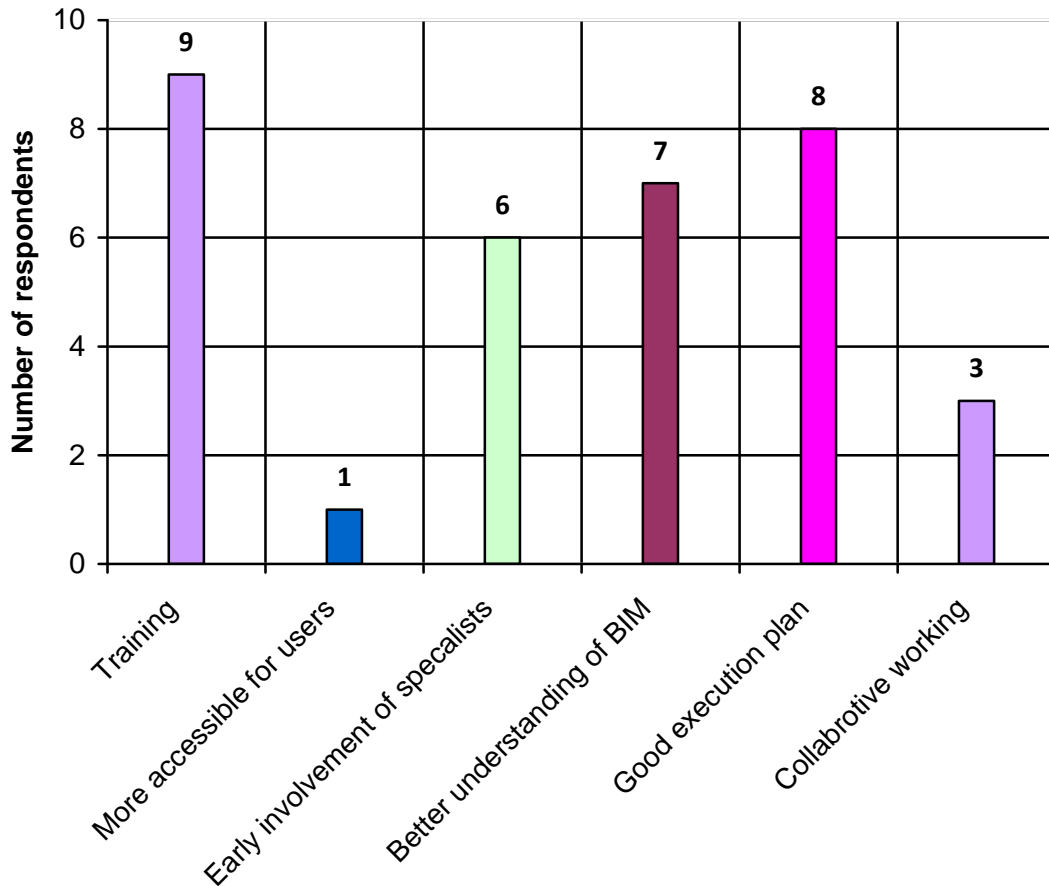
Respondents were also given the opportunity to provide comments at the end of 14 to briefly describe the development plan that was in place, below is a summary of the key comments received; the full list of comments can be viewed in appendix 3:

**Key Comments on BIM development plan:**

- *“Designer Leaders championing change”.*  
(façade contractor)
- *“Whole team now dedicated to delivery of BIM”.*  
(Architectural practice)
- *“We value assess implementation on every job, we are running internal/external training, we have a support team for implementation (working with our broader project partners”.*  
(Architectural practice)
- *“Over the next 6 months training and buying software. Within next 12 months offering drawing service in BIM”.*  
(façade contractor)
- *“Intention to utilise BIM on all projects”.*  
(Main contractor)

A positive response was received from each group of respondents; architectural practices seem to be leading the way for BIM implementation by dedicating their whole team to BIM, and by having an internal BIM implementation support team. This also coincides with the results from questions 11 and 12 which highlights that architectural practices have the most people dedicated to BIM, and have completed the most projects using this process.

Question 15 was an open ended question (*what do you think is the key to successful BIM implementation?*) to give respondents the opportunity to provide their own personal views on BIM adoption. In total 35 comments were received which have been organised into 6 categories, the results of this are illustrated in figure 3.17 below.



**Figure 3.17 key to successful BIM implementation**

The results show that training, better understanding and a good execution plan are the key considerations when considering BIM implementation. The 3 main BIM considerations can be related to each other, for example to gain a better understanding training is required, as part of the initial training it would be beneficial to learn how to execute BIM for the façade design process in terms of planning, procedures and general working methods. It is perceived that a good execution plan which is coherent with the façade design workflow will form a foundational framework for façade contractors for the implementation of BIM.

### 3.4 Interview with John Orrell RIBA & DLA

In May 2014, an interview took place with John Orrell who is the director of DLA architects, and was one of the contributing authors for the new RIBA (Royal Institute of British Architects) stages of work. The purpose of the interview was to establish his views on BIM and the key benefits that are currently being experienced on BIM projects within DLA. John Orrell is a strong believer that BIM has huge potential and will benefit all

disciplines in the construction industry. DLA architects are early adopters of BIM and primarily use BIM on all projects as standard.

The new RIBA stages of work released in 2013 was discussed in detail with regards to how the stages have been realigned to accommodate BIM. It was stated during the interview that the main driver behind the new stages of work was to incorporate sub-contractors and specialist works which was not accounted for in the old RIBA stages of work.

It was discussed that the need for earlier collaboration between the lead design team and the specialist contractor is one of the reasons realignment of the RIBA plan of works, it was also stated that to ensure successful BIM implementation, it is important to appoint specialist design teams such as the facade contractor as early as possible. Uncertainty was raised with regards to construction procurement routes and how these will need to be carefully considered in the future in terms of the most suitable for BIM deployment.

BIM adoption within DLA was discussed at length, it was indicated that BIM is now standard practice on all projects and all of their architectural technicians are using Autodesk Revit for all design works. The switch to BIM for DLA has provided a clear ROI, and has delivered project benefits such as better pre-conception of building performance, visual advantages, 3D perspectives and virtual walkthroughs to present to their clients. DLA have also completed over 15 projects utilising BIM level 2, which included the federation of the architectural, structural and MEP BIM models for clash detection and design coordination. It was stated that there were no specialist contractors involved on any of these projects hence the perception from DLA being that specialist contractors are not yet fully up to speed with 3D/BIM technology.

It was suggested that the key to BIM implementation was to have a development plan in place for training of staff, DLA have 'BIM champions' who train and pass on their BIM and Revit knowledge to other team members. Having a simple plan for the execution of BIM was also a key factor, it was stated that the plan should be in place prior to commencement of any BIM project and adjusted to suit project specific requirements.

### **3.5 Summary of results and discussion**

#### **Mace façade/BIM workshop:**

The key finding from the Mace workshop was that the UK façade industry is generally at level 1 BIM maturity. This was unexpected as it was anticipated that level of BIM maturity

especially with the companies who operate worldwide such as Lindner Schmidlin and Permasteelisa would have been more advanced, however this was not the case. It was found that the majority of façade contractors were at the same level and generally had the same questions and concerns with regards to understanding the collaborative approach to BIM and its processes. There were a number of questions raised in relation to the design process and the how façade design process will work using BIM enabled software, the main concern being that the software is not set up to accommodate the complexities of façade design.

Objective 5 of this research (*examine the capabilities of BIM enabled software*) was developed in order to address some of the concerns and issues raised with regards to BIM enabled software for façade design, a full analysis of this is outlined in chapter 4.

In terms of BIM processes and workflow, objective 6 was developed to examine the transition from 2D to 3D design and how the design process will work in a 3D environment, this is analysed in chapter 5 which reviews technology, people and processes.

#### **Level of detail survey:**

The survey highlighted that procurement routes and time scales for BIM implementation on construction projects are important factors, especially as the BIM learning curve for the majority of façade contractors has only just started therefore sufficient time is required for model development and to become accustomed to working in a 3D environment.

It is suggested that an independent body such as CWCT should develop a protocol in the form of a technical note in order to set out clear guidelines for the façade industry for BIM implementation. These guidelines should consider the complexities of façade design and provide recommendations and guidance for each stage of the construction lifecycle.

It is argued that BIM for façade design may not be appropriate for all projects. Facades with high complexity may be difficult to model in the 3D environment for a number of reasons such as lack of 3D design knowledge, software constraints and time. A decision at tender stage must be made between the key stakeholders to detriment if BIM can be successfully implemented considering the complexities of the project.

The selection for the most appropriate level of detail will help form the basis of chapter 4 which examines Revit / BIM software for façade design details.

### **Industry wide survey:**

Summary of findings from the industry survey:

- The level of BIM interest amongst clients in the industry is medium (Q-6).
- The majority of respondents were aware of BIM, have a development plan in place and intend to use it in the near future (Q-7, 13, 14).
- People currently using BIM are predominantly architects and main contractors (Q-8).
- Level 2 BIM adoption in the façade industry is still at 0% (Q-8 &12) which would correspond with the finding from the façade/BIM workshop in chapter 3.1.
- Architects appear to be at the forefront of BIM implementation considering the number of staff dedicated to BIM (Q-11), and bearing in mind the amount projects completed using BIM (Q-12).
- The most popular BIM enabled software amongst respondents was Autodesk Revit (Q-10).

Considering objective 2 of this research which was to examine the adoption levels of BIM in the construction industry, the survey concludes that architectural practices have the highest adoption levels. The evolution of BIM started with architects, and many still see its value emerging from its use in the design phases. Most in the design community, along with many contractors (43%) and owners (41%), say that architects experience a high level of value (Rodriguez J, 2013).

The open ended questions included in both surveys gave respondents the opportunity to voice their opinions on what is key to successful implementation, this also contributed towards objective 3 of this research which was to establish the main barriers of BIM in the construction industry. The results show that the top 5 barriers are related to training requirements, better understanding, learning BIM software, project time scales, and the need for an execution plan.

### **Interview with John Orrell**

The key findings from the interview:

- BIM is advantageous for architects mainly due to the 3D visual and rendering capabilities of BIM software.

- The best way to successfully incorporate BIM is to have a 'BIM champion' within the business to manage the transition, train staff, and develop new processes/workflows.
- Having an execution plan in place prior to commencement of any BIM project is a key requirement in order to manage the BIM process efficiently.

Objective 7 of this research (a towards reference execution plan) was discussed during the interview, the advice provided for this was to keep the plan simple, and to include footnotes to help provide guidance to the reader or the person allocated to complete the plan.

Before developing an execution plan it was important to examine the capabilities of Autodesk Revit in terms of and how typical façade details can be developed using the software, and if the level of detail as per the survey results can be achieved (Chapter 4). It was also important to understand the BIM work flow and collaboration process in terms of information exchange, design review process and roles and responsibilities (chapter 5). The findings from chapter 4 and 5 will form the basis of the execution plan for the façade design process and will take into account the recommendations provided during the interview.

## 4 Utilising BIM software for façade design

### 4.1 The transition from 2D to 3D

With any transition whether it's a new procedures or in this case new software, there will always be a learning curve involved. The transition from 2D CAD which is predominantly used by the façade industry to BIM software such as Revit will no doubt present its challenges. Autodesk Author Krygiel E et al (2009) suggests that if you have never worked in a 3D environment it may be frustrating to start with as it is a completely new way of approaching design, he also summaries the benefits of Revit and the switch to working in a 3D environment:

*"You'll perform tasks in Revit that you never had in CAD: conversely, some of the CAD tasks that took weeks (chamfering and trimming thousands of lines to draw walls properly or making a door schedule) take almost no time in Revit"* (Krygiel E et al, 2009).

*"It's really quite nice to have immediate access to perspective views at any time! The Revit world is one with a white screen, no layers and no cross references"* (Krygiel E et al, 2009).

Following personal communications with experienced Revit users from Arup and DLA architects, the following comments were made in relation to making the switch to Revit:

*"Anyone can jump on a cad machine and easily learn AutoCAD, Revit however is much more sophisticated and you need to know what you are doing before you start modelling, if you don't this can cause problems further down the line when the model is shared"*. (Belic, pers. comm., 17th June 2014).

*We still use a mixture of 3D and 2D design for more complicated details; these should not be modelled as a 3D component as it takes too long and will bloat the model. You can create a detail item family with all the technical line weights etc. to be dropped into specific drawings where necessary, this is much more efficient."* (Anderson, pers. comm., 12th June 2014).

Utilizing BIM enabled software can be considered as an environmental change for the industry and users are already seeing the benefits it can provide. It is claimed that the BIM environment will make construction easier, and will inevitably change the processes and behaviour of the façade supply chain unlocking new and better ways of approaching project design.



## **4.2 Level of detail for BIM**

Further to the research undertaken in chapter 3 in relation to the level of detail for BIM, the general consensus amongst the façade contractors is that the following key items should be included in the BIM model for façade design details:

- Detailed extrusions
- Gaskets
- Tolerance gap between frame and structure
- Membrane locations
- Perimeter closer pressings
- Glass configuration

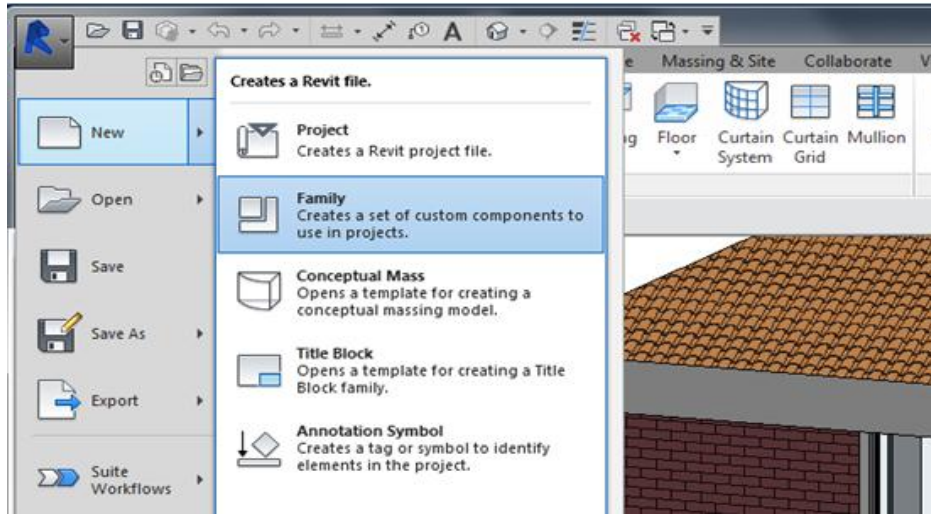
It was established through online research, personnel communications and by carrying out computer based analyses using Autodesk Revit that it is possible to fully model the façade components listed above in the 3D environment, however this is not advised as too many model lines will have a negative effect on the performance of the model. In light of this, a solution was devised which is illustrated in chapter 4.3 comprising a step by step workflow for developing façade specific interface details for windows, doors and curtain wall. This solution was developed in order to facilitate the appropriate level of detail for façade design, taking into consideration that over modelling and too much detail is not good practice due to the subsequent negative effects on model performance.

## **4.3 Creating curtain wall details for BIM**

The workflow below was developed using Autodesk Revit 2015 and AutoCAD 2013.

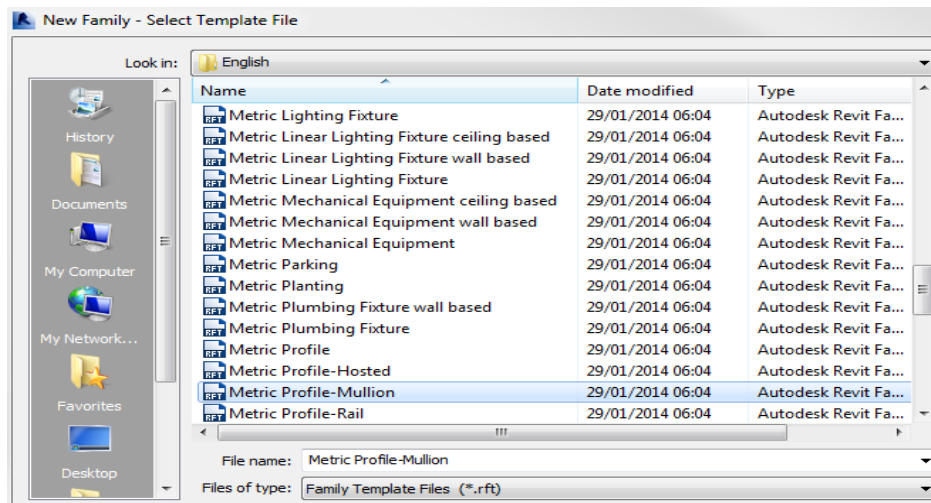
The first step is to create a new mullion profile family by selecting the 'new family' option on the Revit toolbar. It is important at this stage to concentrate on the outline of the curtain wall profiles and ignore the detail components. The level of detail shown in CAD should not be modelled in 3D as it will make the file too heavy.

## STEP 1: Create new family

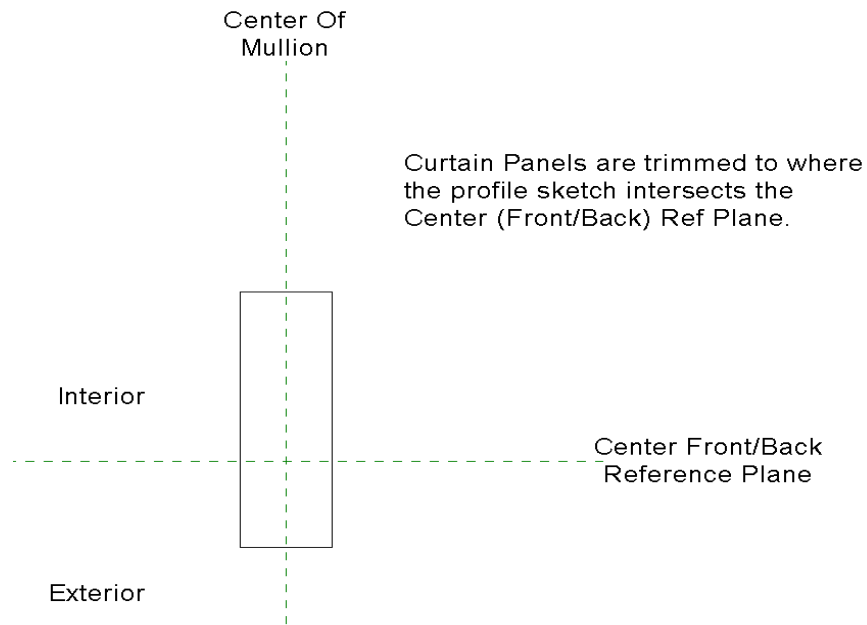


When creating new curtain wall families in Revit, profile templates can be utilised which have been specifically designed for the development of new components for the BIM environment.

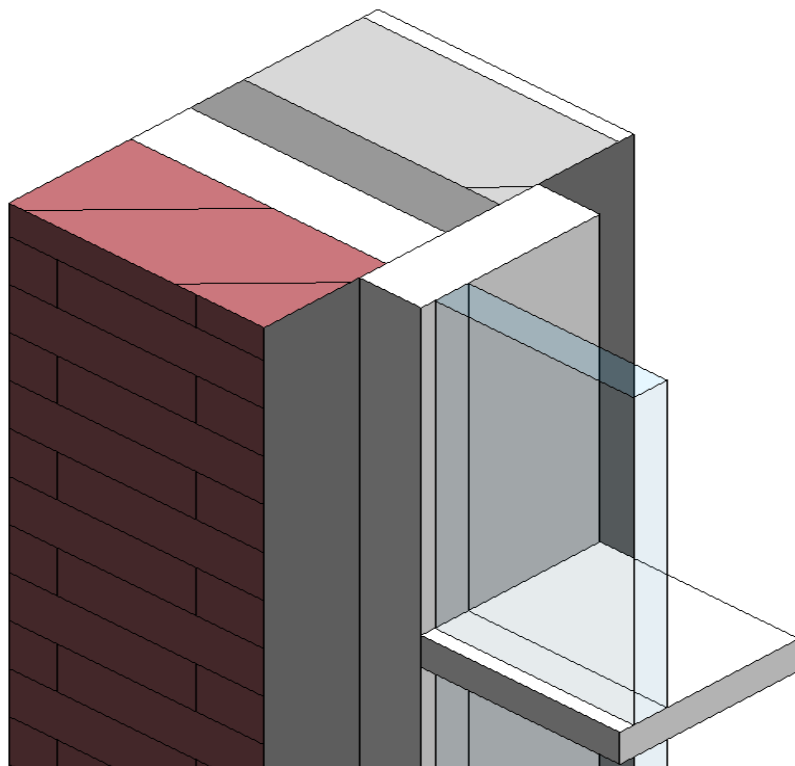
## STEP 2: Select Metric profile mullion template



The template for the mullion profile comprises vertical and horizontal reference lines to determine the position of the mullion when imported into Revit. The basic mullion profiles in Revit are positioned on the centre line as shown in figure 4.1, when the mullion is imported into Revit it will be positioned hard up against the structure as shown in figure-4.2. Considering the appropriate level of detail, the mullion should be set approximately 30mm away from the structure to allow for site tolerance, insulation, and for air seal/ weathering membranes.



**Figure 4.1:** Revit mullion profile template

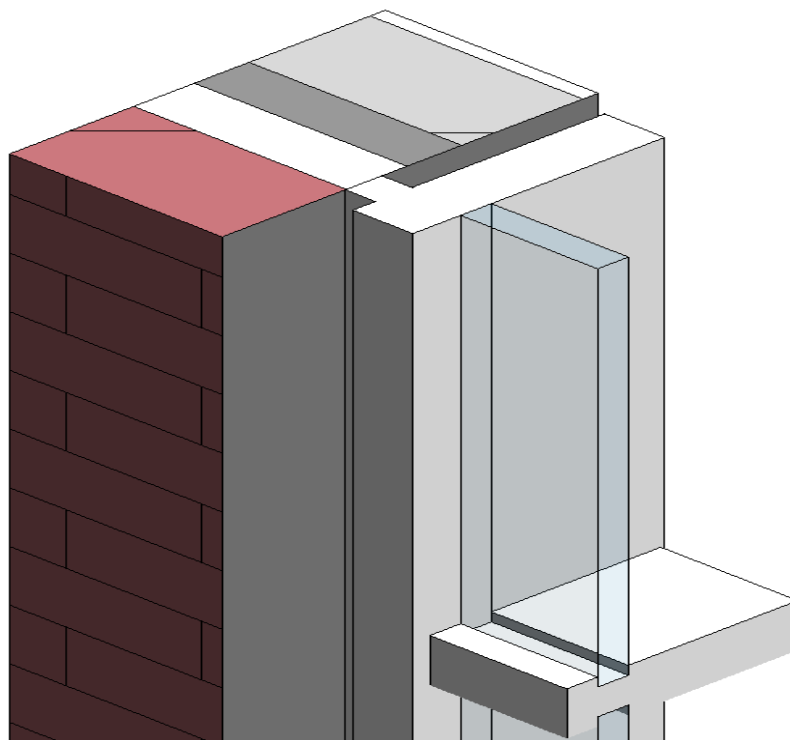
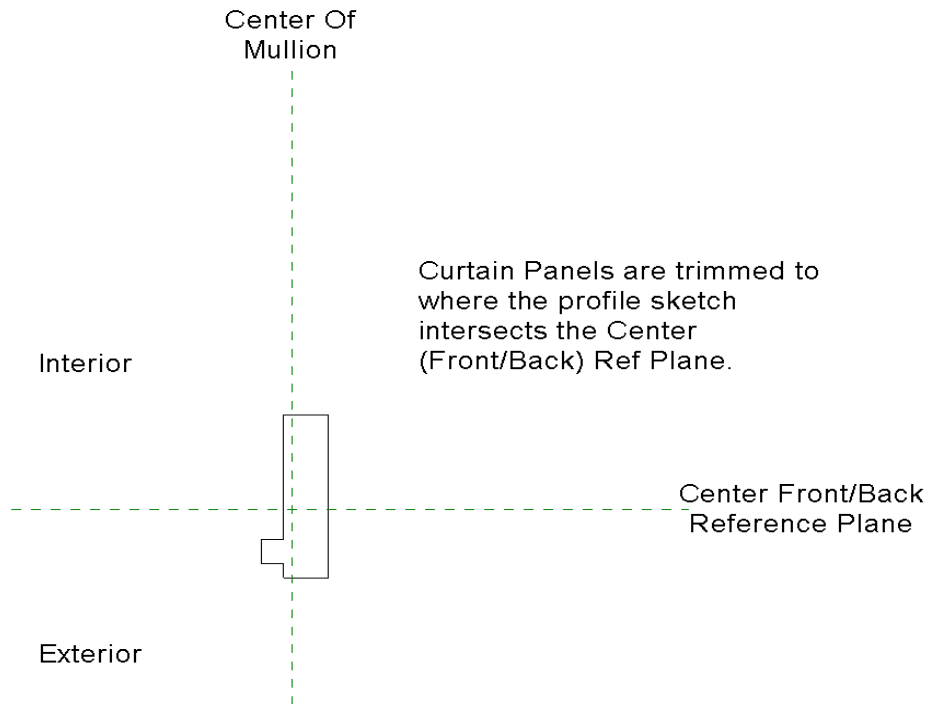


**Figure 4.2:** 3D view of mullion in BIM model

When creating a mullion profile it is important to consider how the edge profile is drawn as the mullion profile will need to touch the structural wall for Revit to recognise the room as a closed boundary. In light of this, the next step is to incorporate an edge profile in the

mullion template, then offset the profile by 30mm from the central reference point as shown below.

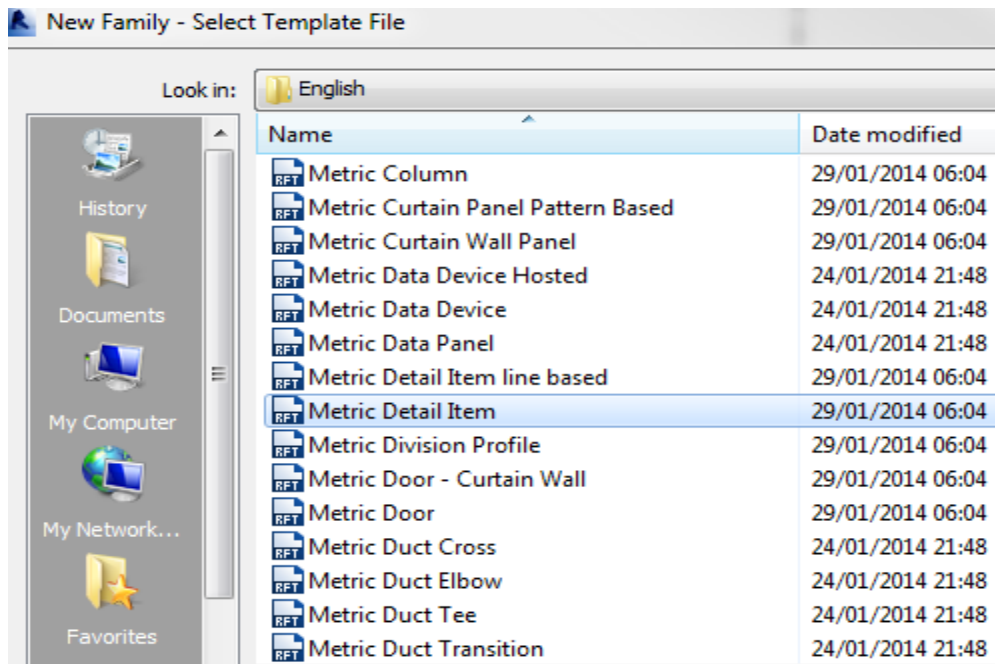
**STEP 3: Create offset mullion with edge profile**



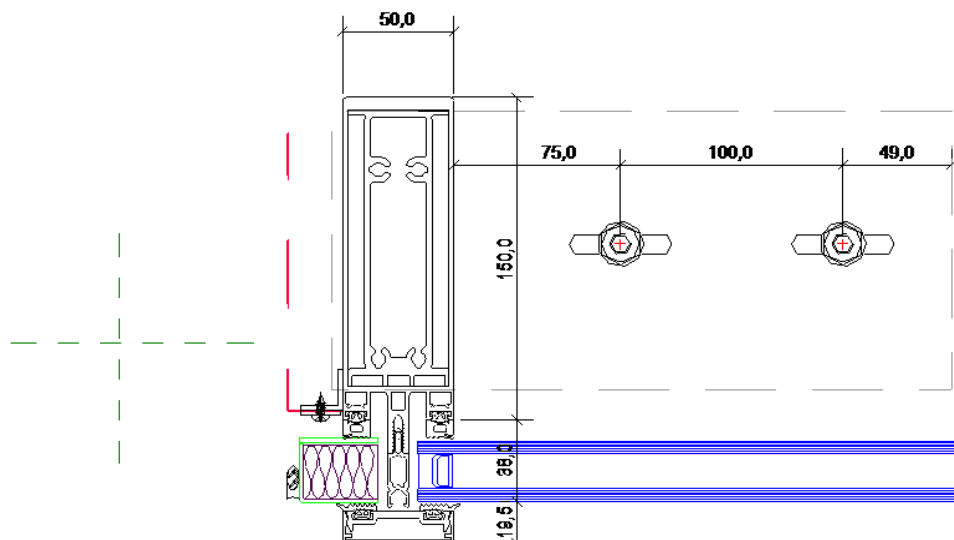
**Figure 4.3:** 3D view of offset mullion

A detail component family can then be added to the detail or drafting a view which can be defined as 2D overlay against the 3D model components. You can create a detail item family's with all the technical line weights etc. to be dropped into specific locations in the model where necessary.

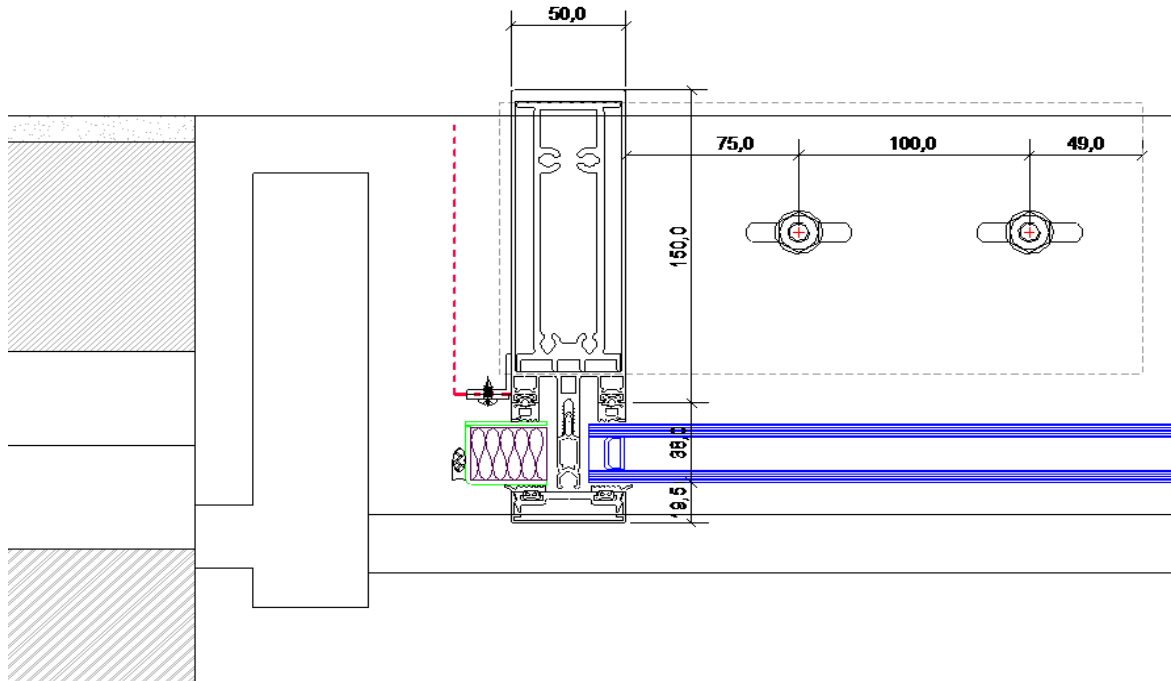
#### STEP 4: Create a new family using the detail item template



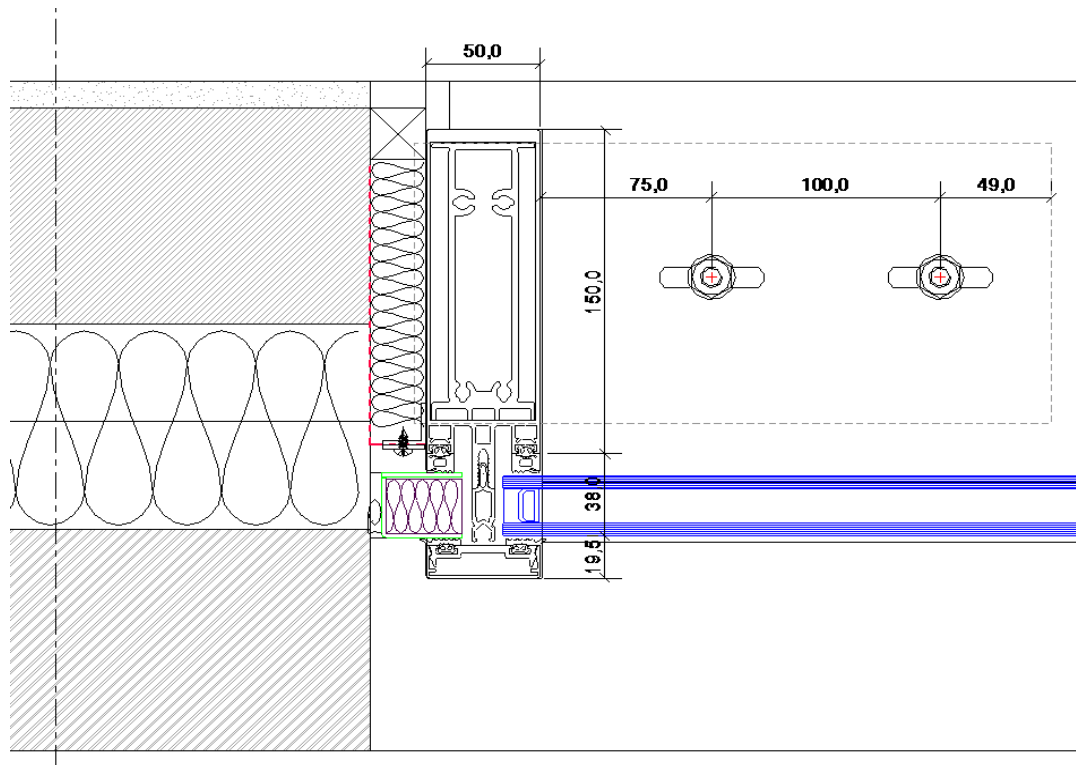
#### STEP 5: In the detail template, import 2D CAD drawing



**STEP 6: Import the 2D detail family into the Revit model**

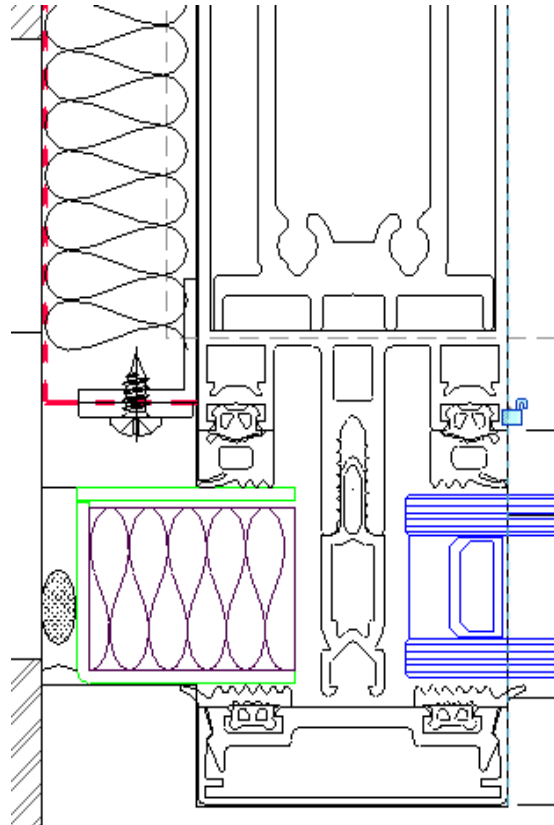


**STEP 7: Position the detail family over the model lines**



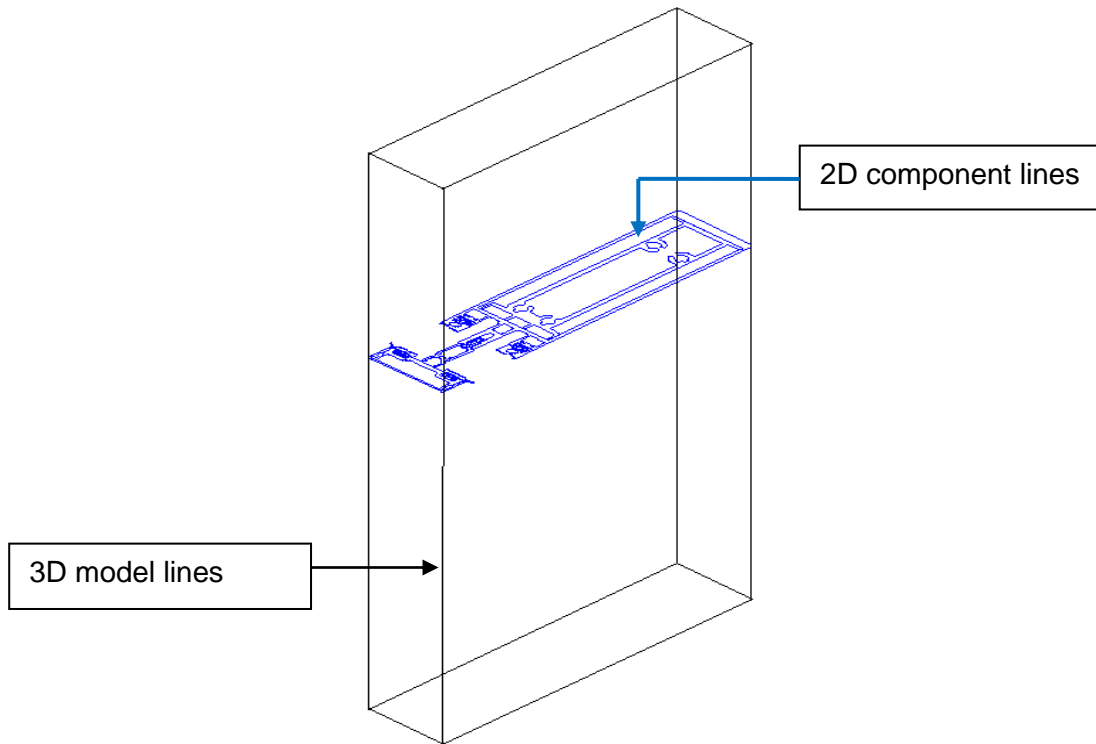
The detail family is easily located if the outer profiles match up and can be constrained to the model lines. To do this, the modify/align tool can be used to ensure the 2D detail and the model lines are accurately aligned, once aligned a small lock will appear as shown below, when the lock is selected this will then constrain the 2D detail component to the 3D model lines so if the model is altered in any way the detail component will follow.

**STEP 9: Use the align tool to constrain the 2D detail to the model line**

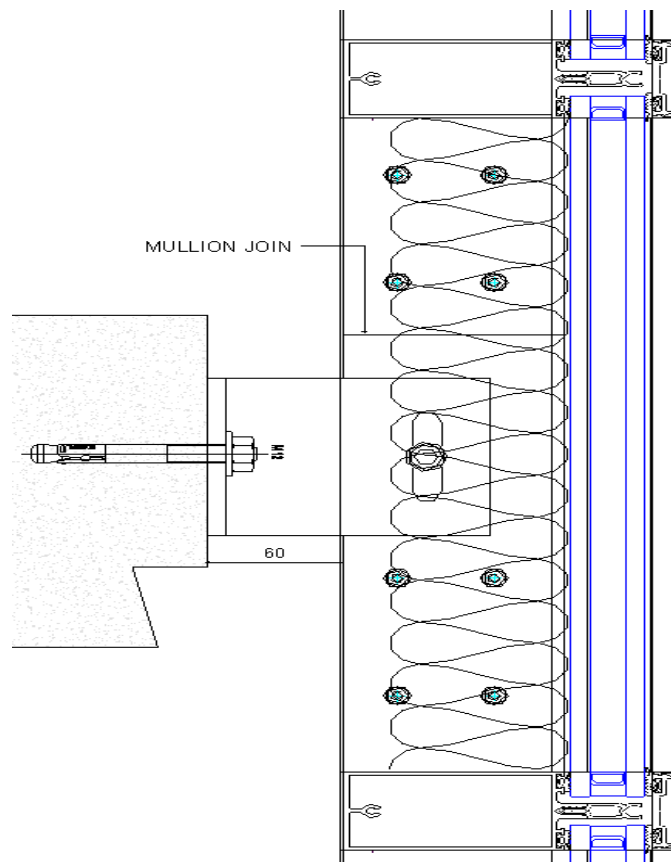


This method of applying 2D detail overlays against the 3D model lines achieves the appropriate level of detail and keeps the quantity and complexity of model lines to a minimum. An example of 3D model lines versus 2D detail lines is shown in figure 4.4; you can see that if the 2D detail was a 3D extruded model component, the amount of model lines will be excessive which would significantly increase the size of the 3D model.

The 2D overlay process illustrated above can be applied to any area of the façade that requires more detail. An example of this is shown in figure-4.5 which incorporates a curtain wall intermediate fixing bracket, mullion joint location, fixing arrangement and profile lines. The same detail in the 3D environment is shown in figure-4.6, you can see that the model lines are simple shapes to keep complexity to a minimum, and the 2D section comprises the detail components.

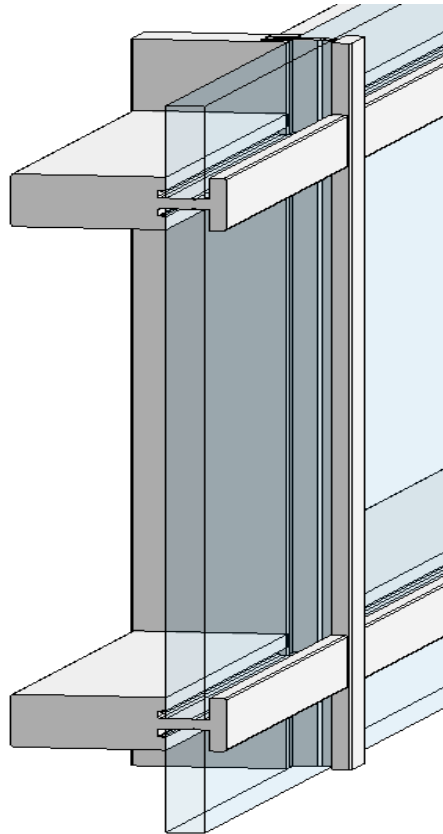


**Figure 4.4:** 3D model lines versus 2D component lines



**Figure 4.5:** 2D detail overlay





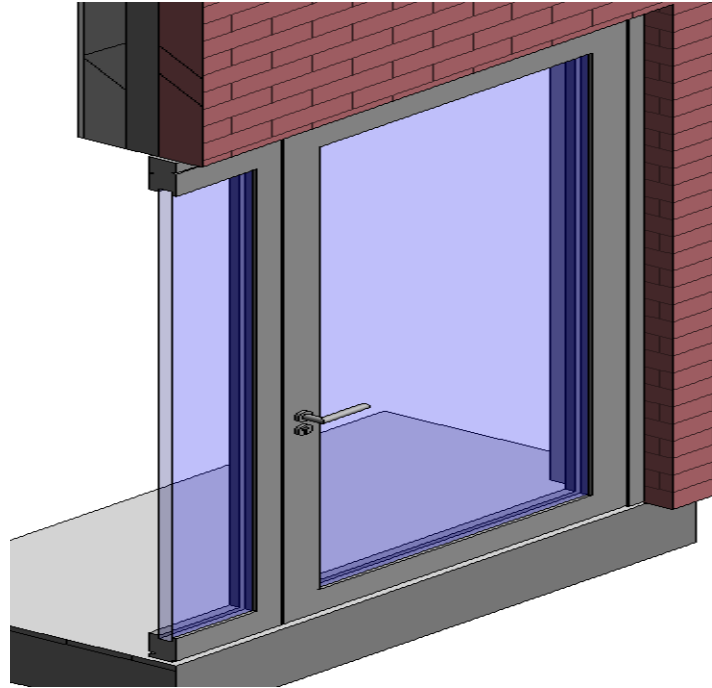
**Figure 4.6:** Revit 3D model view of curtain wall section

By separating a detail into both live model elements and view-specific embellishments, we achieve the best of both worlds: we have an underlay that remains live and changes automatically with the overall building model and we have all of the additional data required to convey design intent occurring only on the specific detail view, thus saving on overhead and unnecessary modelling effort (Aubin F, 2011).

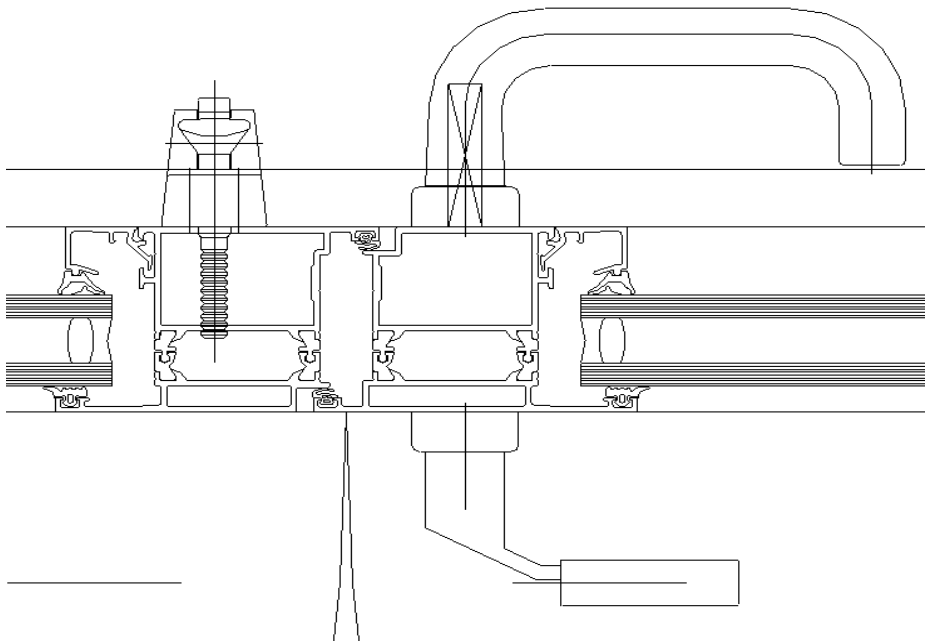
#### **4.4 Creating window & door details for BIM**

System supply chains such as Schuco have started to develop BIM library's for their windows and door systems which can be imported into Revit as families. These families have dynamic change functions set up to enable users to easily change the orientation of the window/door component in terms of opening direction, perimeter tolerance gaps and size. The BIM families provide an acceptable level of detail (figure-4.8 & 4.9) incorporating gaskets, ironmongery and profiles, and have been created using the same 2D overlay method as illustrated in chapter 4.3. Annotation can be added to the model in the 2D view either by using the 2D overlay principle, or if it is a simple case of adding a fixing

arrangement, insulation, silicone sealant etc. the Revit annotation function can be utilised, an example of this is shown in figure-4.10.



**Figure 4.7:** 3D view of door in Revit Model



**Figure 4.8:** 2D section of door meeting stiles

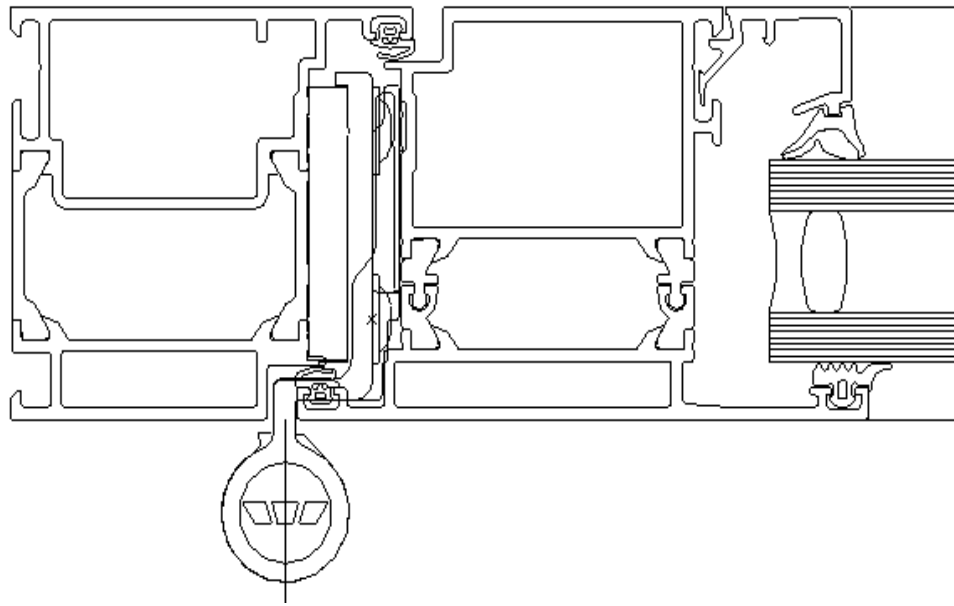


Figure 4.9: 2D plan section of door jamb

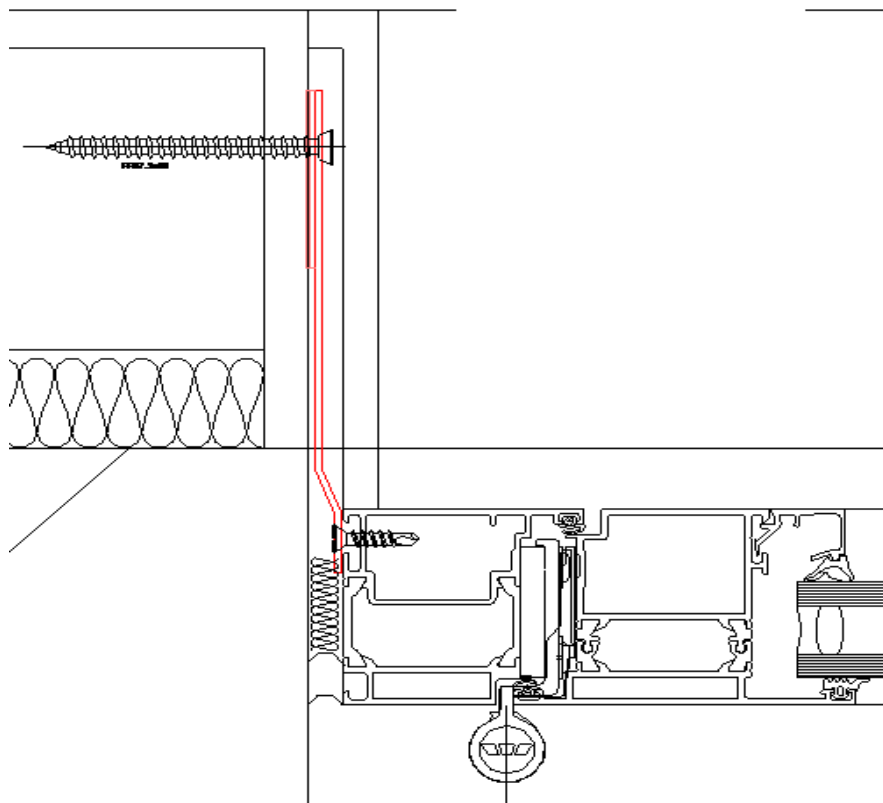


Figure 4.10: Detail using Revit annotation function

The BIM door and window families created by the system suppliers provide users with a great amount of flexibility to facilitate project specific requirements. Unfortunately system suppliers have not gone to this level of refinement for curtain wall families and it is unknown why this is the case, however it is assumed that as BIM is still in the early stages of development and façade contractors are not yet fully on board with BIM, there is currently not a huge demand for these refined curtain wall families.

If this level of refinement can be achieved for window and door families, it is expected that curtain wall families can be developed in a similar way with multiple dynamic change functions. As curtain wall interfaces often vary to suit project specific or structural requirements, an approach to accommodate this would be to develop curtain wall families with basic interchangeable functions allowing users to easily adjust basic parameters such as:

- Perimeter tolerance gap
- Height and width of curtain wall
- Mullion/transom box sizes
- Glass thickness
- Position of mullion joint

This workflow in Revit provides an overview of a potential method to facilitate the high level of detail required for façade interfaces. It is anticipated that when BIM becomes more commonly used in the façade industry that methods of achieving detail will evolve and develop over time (with help from the system suppliers) which will make this process more efficient. When 2D AutoCAD was first released in 1982 the user interface was very basic, over the years CAD has been constantly updated to help improve the user interface and to meet customer needs. It is anticipated that BIM enabled software will also go through the same refinement process.

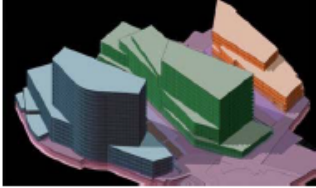
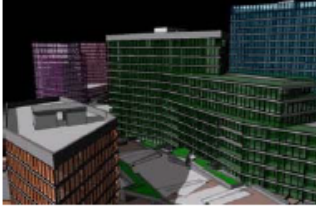

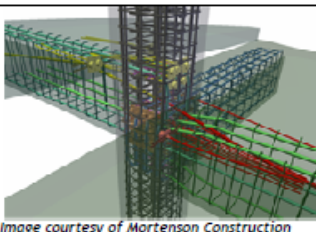

An important consideration with regards to level of detail/development is applying it to the BIM model at the right time; chapter 4.5 investigates this further.

#### 4.5 Applying detail at the right time

During the design process, it is important that model stage definitions and the LOD are clearly defined for the BIM model for each stage of the building lifecycle. PAS 1192-2:2013 defines 7 levels of model definitions:

1. **Brief** - Graphical information, performance requirements, benchmarks and constraints (model may not exist at this stage)
2. **Concept** – Graphical design massing to represent building or facility to show aesthetic intent, model will be subject to design development at this stage.
3. **Definition** – Model to be dimensionally correct and appropriate for early contractor engagement for estimating and design purposes.
4. **Design** – Model to include sub-contractors design information that can be used for fabrication, coordination, sequencing and to verify compliance to the project specification.
5. **Build and commission** – All BIM models incorporating sub-contractors design information to be federated before construction providing accurate information for sequencing and installation.
6. **Handover and closeout** – Model to include all necessary data and as built information required for operation and maintenance.
7. **Operation and in use**- Model to be compared and verified against EIR's in terms of specification and performance. The model should be updated accordingly with maintenance records and changes made to the building or facility.

LOD is the process of applying the appropriate detail to the BIM model in accordance with the key project stages listed above. There are differing systems used to define the LOD, the standards generally used in the UK are based on the proposed LOD definitions defined by AIA Doc E202 – 2008. There are no specific standards in the UK for LOD, some clients may even develop and operate their own LOD based on project specific requirements; the definition of each LOD proposed by AIA is illustrated in figure 4.8 below.

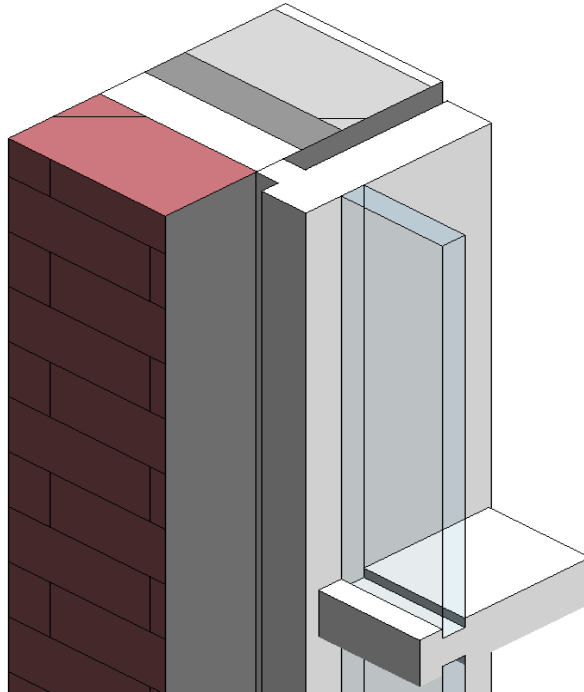
	<p>LOD 100 – Essentially the equivalent of conceptual design, the model would consist of overall building massing and the downstream users are authorized to perform whole building types of analysis (volume, building orientation, cost per square foot, etc.)</p>
	<p>LOD 200 - Similar to schematic design or design development, the model would consist of "generalized systems or assemblies with approximate quantities, size, shape, location and orientation." Authorized uses would include "analysis of selected systems by application of generalized performance criteria."</p>
	<p>LOD 300 - Model elements are suitable for the generation of traditional construction documents and shop drawings. As such, analysis and simulation is authorized for detailed elements and systems.</p>
 <p><small>Image courtesy of Mortenson Construction</small></p>	<p>LOD 400 - This level of development is considered to be suitable for fabrication and assembly. The MEA for this LOD is most likely to be the trade contractor or fabricator as it is usually outside the scope of the architect's or engineer's services or would constitute severe risk exposure if such parties are not adequately insured.</p>
	<p>LOD 500 - The final level of development represents the project as it has been constructed - the as-built conditions. The model is suitable for maintenance and operations of the facility.</p>

**Figure 4.11:** Defined level of detail/development, BIM guide (nd) College of the desert

David Philp (2013) highlights the importance of providing the right information at the right time: *“What is key for the product manufacturers is providing the right amount of information at the right time. I am often seeing BIM objects that are too detailed in their information for design stage. The Digital Plan of Work is a standard that looks at the appropriate levels of development needed. At conceptual stage providing a high level of detail in your BIM object holds no value”* (David Philp, 2013).

Façade contractors are likely to operate between stages 3 and 6, and may start applying detail to the model at LOD 300. LOD-300 for the design of the façade will encompass the elements modelled or drawn as generalized components comprising accurate shape, quantity, size, orientation and location. This LOD can be related to chapter 4.2 (creating

curtain wall interfaces) that recommends ignoring the detail at this stage and concentrating on the outline of the façade component as shown in figure 4.12.



**Figure 4.12:** LOD-300, Outline of components

LOD 400 can be related to the 2D detail overlay stage (chapter 4.2) which provides accurate and specific details of the façade components including gaskets, mullion/transom profiles, glazing configuration etc. This LOD should be appropriate to allow procurement and manufacture to commence.

Taking on board the comments with from David Phil with regards applying the right detail at the right time, it is important that there is a defined protocol for the LOD for the façade design process. PAS 1192-2-2013 provides model status codes for subcontractors to define how the model information may be used at different stages in the CDE in order to assist with coordination and development procedures. (Model status codes appendix-5)

It is not clearly defined in PAS 1192-2:2013 how the model status codes relate to the LOD at each stage of the design process, below is a recommendation on how the specific model status codes can be associated to the LOD for the façade design process:

- **Model status S2 –for information LOD 200**

This may be appropriate when the façade contractor is involved early in the design process to assist with the design development. LOD 200 can be defined as schematic design which the process of applying approximate information in terms of sizes, shape, and location.

- **Model status S3 –for internal review LOD -300**

The LOD at this stage should include accurate shape, quantity, size, orientation and location of the façade components. This will be the outline stage in order to provide accurate set out information of the façade package to facilitate design coordination with other trades, clash detection and design development.

- **Model status S4 –for construction approval LOD-400**

The model should include the appropriate level of detail for façade interfaces utilising the 2D overlay principle, it should be clear at this stage how the façade envelope materials and components are combined to meet with the building specification and performance requirements. The model should include enough information to enable the lead designer to provide approval/signoff to allow the façade contractor to proceed with procurement and manufacture.

- **Model status S5 - Construction issue LOD-400**

This will be the construction issue/fully coordinated model incorporating any adjustments or comments received from the S4 status issue. The model should be in line with the EIR's and should enable the façade contractor to proceed with procurement and manufacture.

### **Summary of BIM software:**

The key issue with regards to the transition from 2D to 3D is learning the software, however It is a waste of time sending staff on Revit training courses if they are not going to carry on using it on a regular basis, typically people who don't use it for period of time tend not to remember much of the training. The learning of Revit for façade designers will be frustrating to start with as Revit was designed for architects therefore the functions and the user interface is more for architecture. Even with basic Revit training, you will find that when using Revit on a live project, things will be completely different, especially when things are not working as smoothly as the training sessions and you are up against



programme. The most appropriate strategy would be to time the training in conjunction with project kick-off, and ensure that the training is tailored to suit façade design.

The transition from 2D to 3D needs to have a well-defined process in place, however a well-defined process is only as good as the people and their knowledge base, you need the people to embrace this new technology and actively seek opportunities to apply it. People in the façade industry should be prepared for some workflow changes, and should help shape the BIM workflow in terms developing Revit families, applying LOD, and exchanging information. There should also be QA sessions within the work place to organise questions, problems and difficulties experienced in order to progress everyone's skills.

Following the analyses of Revit, chapter 5 is a review of the BIM design work flow in terms of roles and responsibilities, information exchange and collaborative working.

## 5 BIM design workflow and collaboration

The following chapters are split into 2 categories which are people and processes to help understand the different components of BIM implementation. Doing so will help organize and properly align people and processes within the organisation.

### 5.1 BIM Roles and responsibilities (people)

On any project it is important to ensure that roles and responsibilities of each team member are clearly defined from the start, the implementation of level 2 BIM is defined as:

*“a series of federated models prepared by different design teams (the number of models and purpose to be determined by the Employer), put together in the context of a common framework for the purpose of being used for a single project with licences granted to other project teams members to use the information contained in the federated models”.*

Undom K (2012)

Prior to the initiation of any modelling for the project, it should be agreed who has responsibility for the management of the building model at each project phase. This management of the model may change throughout the project as different stages are reached in the design process. In addition to the roles during the traditional design process, PAS-1192-2 (2013) defines the following roles that need to be considered when implementing BIM:

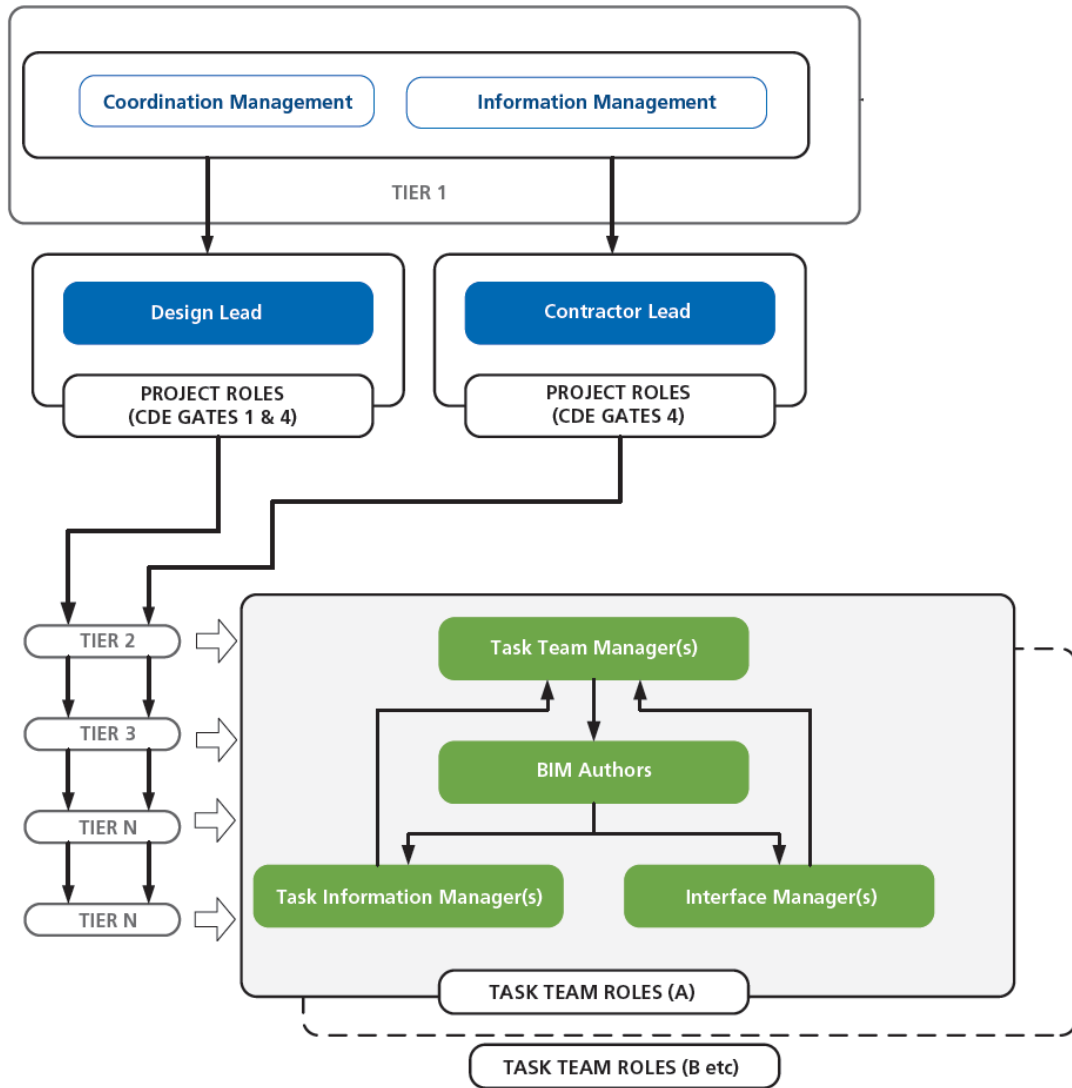
- **Information management** - assigned to coordinate manage the CDE similar to a document controller (this role has no design responsibility).
- **Project delivery management** – assigned to assure that suppliers/sub-contractors are able to deliver the required information.
- **Lead designer** – responsible for the overall coordination of the design information in terms of design approvals in the CDE, design changes, and confirms all design deliverables.
- **Task team manager** – Responsible for the production of design outputs for a specific works package and issuing approved information within the CDE.
- **Task information manager** – responsible to ensure that the information produced is suitable for the CDE and is in line with the relevant BIM standards.

- **Interface manager** – assigned to coordinate the design on behalf of the task team, and to propose resolutions to coordination problems and clashes.
- **Information originator** – assigned to develop and take ownership of the model information.

The BIM task group (2013) and PAS-1192-2 (2013) highlight the importance of 1 role in particular for successful BIM implementation. The information manager is responsible for the setting up and managing the flow of information through the CDE at each stage of the project lifecycle. The CDE in conjunction with BIM is an essential tool for quality control, information management, and effective collaboration. A key function during level 2 BIM is the federation of multiple BIM models for design review/coordination and clash detection, the information manager is responsible for this process ensuring that quality and operation standards are met and BIM standards and naming conventions followed. It is anticipated that the person in this role will change during the project lifecycle and may even be undertaken by a team of people depending on project size and complexity.

It is suggested in PAS-1192-2 (2013) that the clarity of these roles and responsibilities are essential to the implementation of level 2 BIM for effective information management, and should be clearly defined in the contractual documents and in the BEP. It is important to remember that that the roles and responsibilities specified in PAS-1192-2 (2013) are for guidance only, and may differ depending on the type of project. It is also anticipated that many of the key roles will be undertaken by the same individual.

The task team roles shown in figure-5.1 below are parties that are appointed to carry out a particular task on the project, for example, the façade contractor will fall into this category and will be tasked with designing, manufacturing and installing the curtain wall.



**Figure 5.1:** Roles and responsibilities, PAS-1192-2 (2013)

Comparing this to the traditional 2D design process utilising a CDE, the roles and responsibility are not significantly different however the terminology and the job descriptions have been realigned to suit the requirements of BIM. Some of the roles and responsibilities defined in PAS-1192-2 are likely to be undertaken by more than 1 person, and in some instances certain responsibilities may be assigned to the task team (e.g. façade contractor) figure 5.2 illustrates this further. (See appendix 4 for defined roles from PAS1192-2-2013).

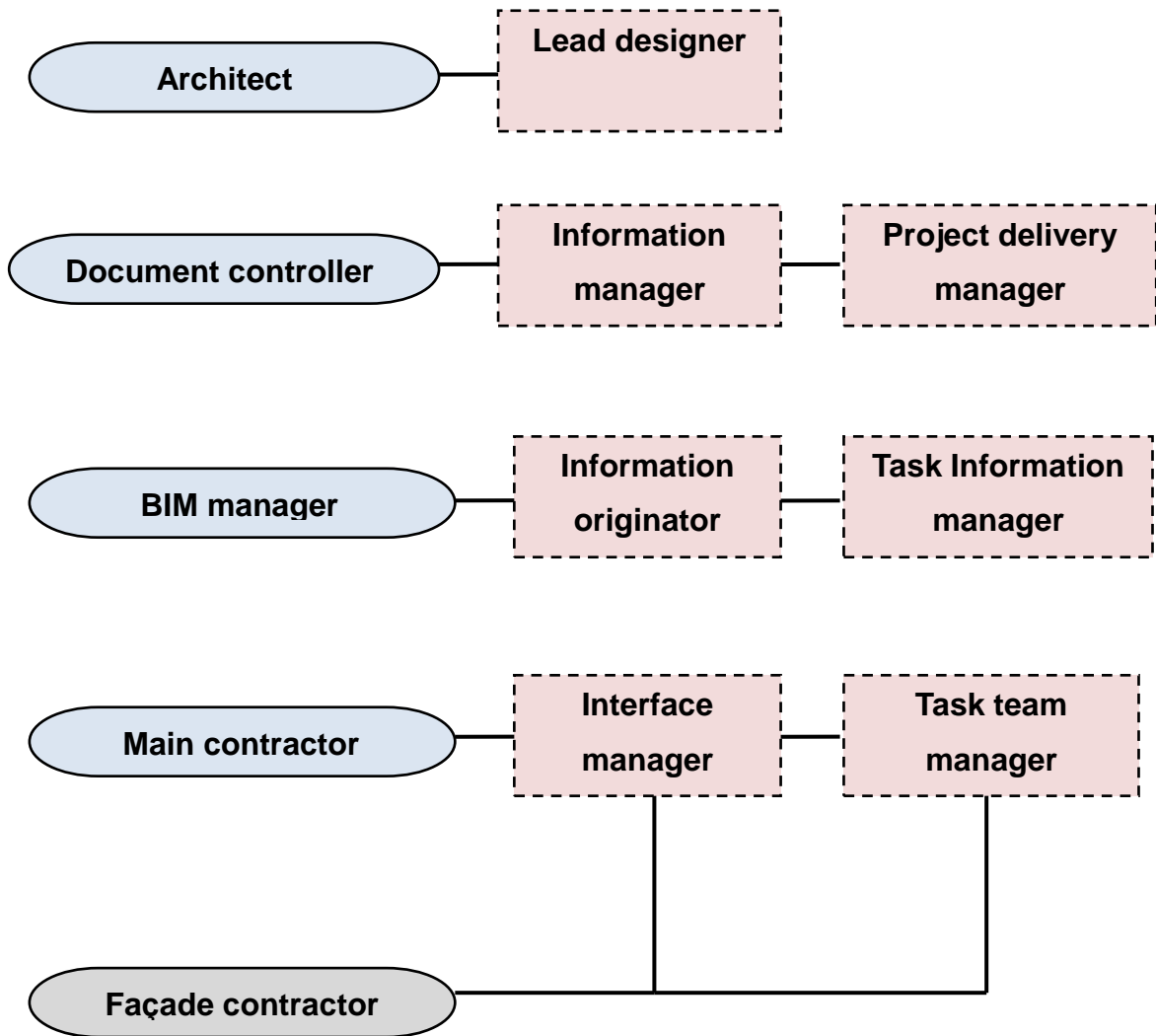


Figure 5.2: Roles and responsibilities

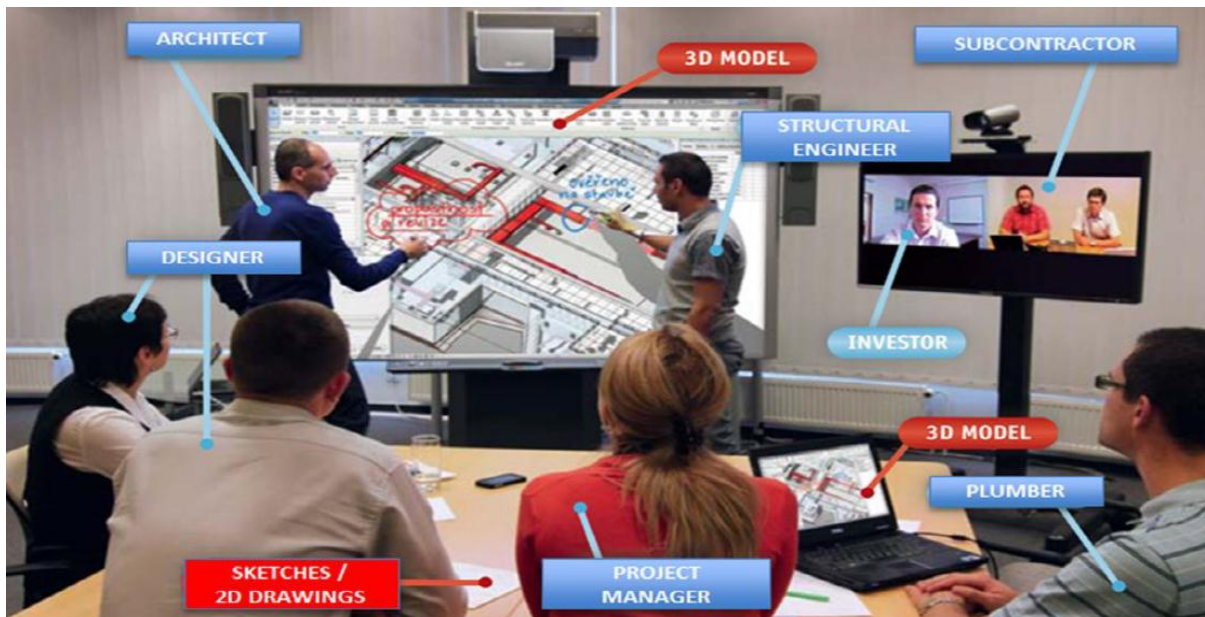
## 5.2 Collaborative working- the big room concept (people)

The nature of the construction industry means that we all have to work together and the processes involved throughout will always remain as a team activity. It is argued that the implementation of BIM will provide better grounds for collaborative working to help achieve greater and more efficient coordination of design information. As BIM promotes collaborative working, Barnes and Davies (2014) suggest that many more hours will be spent in the design process, and far fewer hours will be spent in the production stage (Barnes and Davies, 2014).

Salman A et al (2008) claims that “As the use of BIM accelerates, collaboration within project teams should increase, which will lead to improved profitability, reduced costs, better time management and improved customer/client relationships”.

The big room concept is a term used for collaborative working and team integration when implementing BIM. It is the process of the key members of the design team together in 1 room to examine the BIM model to coordinate the design. DPR constructions (2012) highlight the benefits of this concept:

*“The Integrated Big Room has several different objectives and provides many benefits, both directly and indirectly. First and foremost, it aims to improve collaboration through greater team integration. Early integration enables a team to deliver a higher performing building, on time and on budget”* (DPR construction 2012).



**Figure 5.3:** BIM: A better way of working, David Philp (nd)

An important consideration for the big room meetings is making sure that a structured and organised agenda is in place prior to each meeting to help drive efficiency and productivity. Barista D (2014) highlights the importance of this in order to realize the full benefits of BIM:

*“BIM/VDC tools are great, but if you can’t run efficient, productive coordination meetings, the Building Team will never realize the benefits of true BIM coordination”* Barista D (2014).

*“Inefficient virtual coordination meetings, cumbersome BIM files, and a “rush to model mentality are just some of the profit-eating miscues that are commonplace in the AEC industry”* Barista D (2014).

Barista D (2014) highlights the areas of focus in order to cut waste during BIM implementation and improve BIM workflows:

1. Recognize the importance of ‘tribal knowledge’.
2. Master the art of the BIM coordination meeting.
3. Avoid double modelling whenever you can.
4. Map your processes.
5. Divvy up the model to avoid unwieldy file sizes.
6. Make sure someone ‘owns’ your companywide BIM/VDC standard.
7. Create a simple BEP—and stick to it.

Barista D (2014)

Tribal knowledge can be defined as unwritten information that is not commonly known outside of the tribe or group of people. Barista D (2014) recognises the importance of keeping the same members of the collaboration team together in order to gain consistency throughout the design process. If people leave the team and are replaced by others, a small piece of the project information or ‘tribal knowledge’ is lost.

The coordination meeting should be attended by the relevant team members who have the appropriate knowledge and the expertise in relation to their works package, they should also have the ability to work and navigate in the BIM environment. As more time will be spent during design collaboration, the BIM coordination meeting should only include the relevant people directly involved with the element of works that requires coordination; it is recommended that split meetings are conducted to avoid inefficient coordination meetings and time wasting.

The split teams shown in figure 5.4 will be project specific, and are likely to change during the design process depending on which area of the project is being reviewed, for example if the façade contractor has a series of curtain wall interfaces that relate to the roofing elements, it may be appropriate to include the roofing contractor in the collaboration meeting.

Team -1	Team-2	Team-3
Main contractor	Main contractor	Main contractor
Architect	Architect	Architect
BIM manager	BIM manager	BIM manager
Structural	Façade contractor	Internal fit out
MEP	Façade consultant	Lighting contractor
Roofing contractor	Structural engineer	Flooring contractor

**Figure 5.4:** Spilt BIM coordination meetings

The benefit of having the right people in the room along with regular BIM coordination sessions is emphasized by Barista D (2014):

*“The biggest payoff has come from our team’s early commitment to have weekly BIM coordination sessions throughout the design process it has resulted in a low number of RFIs and very few significant field coordination issues”* Barista D (2014).

To avoid double modelling or constant changes in the 3D environment, it is recommended that hand sketches or basic 3D sketchup drawings are created during the early design stages to help refine and develop the design, this process should take place before adding large amount of detail to the 3D model in order to avoid unnecessary modelling and abortive work. Adequate time should be allocated in the BEP for this design development stage.

Each specialist trade may have relatively different procedures and processes; therefore it may be necessary for them to create their own design execution plan outlining their expectations and proposed workflow for the collaboration and design process. In many sources it is advised that a well-developed concise execution plan is an important document in order to facilitate BIM collaboration, proactive management and is a valuable tool to help achieve the project goals.



In summary of the BIM collaboration process, it is anticipated that specialist contractors will spend more time in project design meetings in order to achieve the end result of a fully coordinated BIM model. Defining roles, responsibilities and expectations at the start of the project is also important and ensuring that the appointed teams are kept the same throughout the design process for consistency and to keep the 'tribal knowledge' intact.

### 5.3 Information exchange (process)

ISO 16739:2013 is an international standard that specifies an exchange file format for BIM data. IFC is common data schema which makes it possible to exchange data between different software platforms during the construction life cycle for BIM. When implementing level 2 BIM, it may be the case that certain specialist subcontractors have their own native model format which is different to other native models; the IFC has been developed in order to convert the format of the model to a neutral platform. This enables the models to be read without having access to the numerous software platforms and allows the models to be federated successfully. Navisworks is commonly used for integrating the IFC models which facilitates whole project review for integrated project coordination and delivery. It allows the project team to analyse the design, resolve conflicts, identify clashes and has advanced visualisation tools to communicate the design intent. The capabilities of Navisworks is analysed in more detail in chapter 5.4.

*"IFC is an object-based file format with a data model developed by building SMART to facilitate interoperability in the architecture, engineering and construction (AEC) industry, and is a commonly used format for BIM. The IFC model specification is open source and is an official International Standard" (ISO 16739:2013).*

The traditional 2D design process uses collaboration platforms such as Conject and 4 projects which are data management systems to allow the multidisciplinary teams to share documents and drawings otherwise known as a CDE. A CDE is defined in British Standard PAS 1192-2:2013 as *"a single-source of information for any given project, used to collect, manage and disseminate all relevant approved project documents for multidisciplinary teams in a managed process"* (PAS 1192-2:2013).

These CDE's are generally set up for the 2D design work flow, it is recognised by the data management system providers that they will need to update and refine their systems to bring them in line with BIM processes. 4 projects (nd) have started to adapt their system to enable BIM to be utilised on construction projects through the CDE, a summary of the key changes being made are as follows:

- A Viewer for 3D BIM models which supports IFC.
- An IFC model review system to facilitate the design and collaboration process which allows model components to be tagged with data i.e. comments, specification and performance.
- An IFC model server which allows multiple models from multiple disciplines to be federated for design review and clash detection.
- A BIM reporting system to highlight and record clash detection.

#### 5.4 Model approval and review process (process)

During the traditional 2D design process, design drawings are usually submitted electronically via a document management system where the drawings are securely stored. These management systems are to enable project team members to access information at any time and are usually set up to notify team members when drawings are issued, they also keep track of drawing revision history, response times and provide an audit trail of all drawings issued and subsequent revisions.

When design drawings are issued by the sub-contractor for approval, someone is usually appointed from the lead design team to review and comment on the drawings, the commented drawings are usually returned to the sub-contractor with an A, B or C status which can be defined as follows:

**Status A** – Drawing approved with no comments, proceed with procurement, manufacture and re-issue the drawing at construction status.

**Status B** - Proceed with procurement and manufacture incorporating the comments provided, and update the drawing to construction status.

**Status C** – Drawing not fit for construction, comments to be incorporated and re-issue the drawing for approval.

The ABC workflow is typically how the design and approval protocol works for the 2D façade design workflow; the question is how will the approval process this work in the BIM environment? Concerns have been raised in the façade industry as there is no defined approval process for the issue and exchange of 3D models. To coincide with BIM technology, more refined tools are required to facilitate the design review and approval process.

3D model management tools have been specifically developed for the 3D BIM environment for the model review and approval process. Navisworks developed by Autodesk is commonly used which brings together and federates native IFC BIM models which can be viewed in a single 3D environment. The software converts the large 3D BIM models into smaller manageable size models, the models combined can be used for interface management, clash avoidance and coordination. The benefits of using Navisworks during the BIM coordination process is defined by Autodesk (nd):

*“Using Navisworks for clash detection during the initial design coordination process, we reduced thousands of clashes to only a handful—helping us save time and money and decrease the overall time spent on design. During construction, Navisworks helped us push the completion of critical areas and significantly increase coordination with the trades. Autodesk (nd)*

The key features of Navisworks are as follows:

- **Redline toolkit**

The software allows the project team to add comments to the model highlighting key areas that need to be reviewed and resolved by the design team. Annotations can be applied to the model in different colours if necessary to help highlight the nature of the problem.



**Figure 5.5:** Mark up a Navisworks model, AEC bytes, (2012)

- **Clash and Interference Management**

Navisworks has the capability to identify, manage and track clashes which can be reviewed by the project team. It is suggested that that the clash detection tool is the

software's greatest strength as it captures the problem in real-time, providing a superior tool to enable the project team to coordinate key interfaces efficiently helping to avoid costly issues during construction.

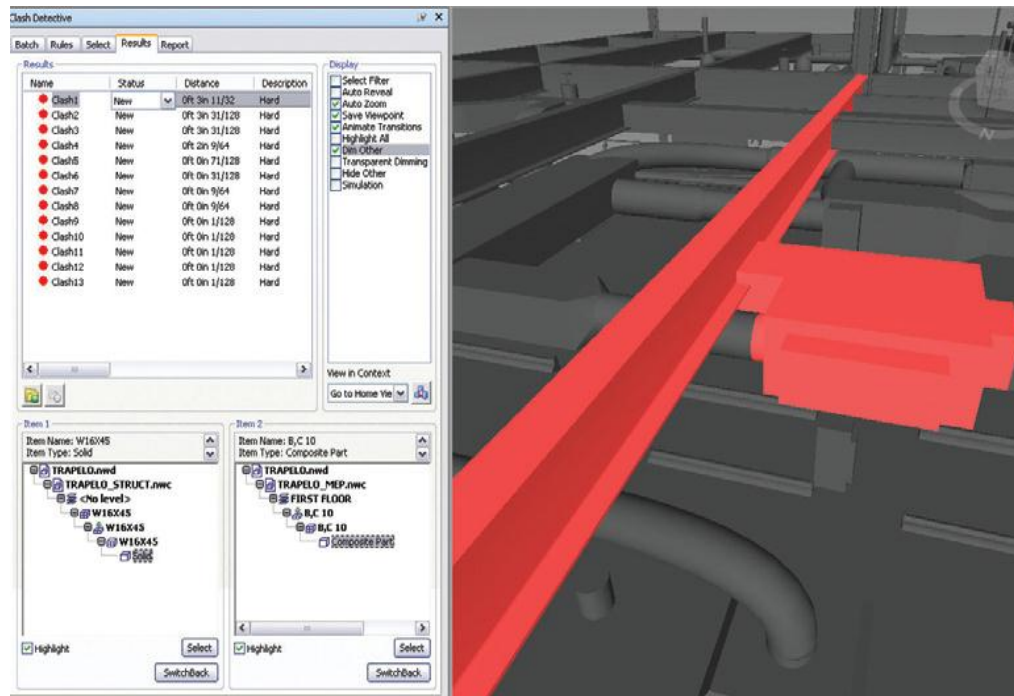


Figure 5.6: Clash interference and detection, Autodesk (nd)

- **Photorealistic Visualization**

Navisworks comprises enhanced visualisation features for simulations, 3D animations, project walkthroughs and renderings. A key benefit of this is highlighted by a client of a recent project where BIM was successfully implemented:

*“For the first time I could understand a building design. It allowed me to contribute and comment both positively and negatively for the first time rather than just having to look at a flat drawing”* (Thomas E 2013).

The software enables the client and the project team to view the project in a 3D environment prior to construction which can improve their understanding of the design. It is anticipated this photo realistic visualisation of the project or facility will provide better grounds for decision making and will help predict the overall visual and technical performance before the ground is even broken.

Autodesk design review allows users to view drawings electronically with digital tools for measuring, mark-up, commenting and annotating design drawings. The 2D drawings

generated from the BIM model can be imported directly into the design review software maintaining their intellectual properties in terms of scale and sizes. The software facilitates a digital approach to the design review process which is arguably more efficient, easier, and less costly than the traditional paper-based mark-up approach.

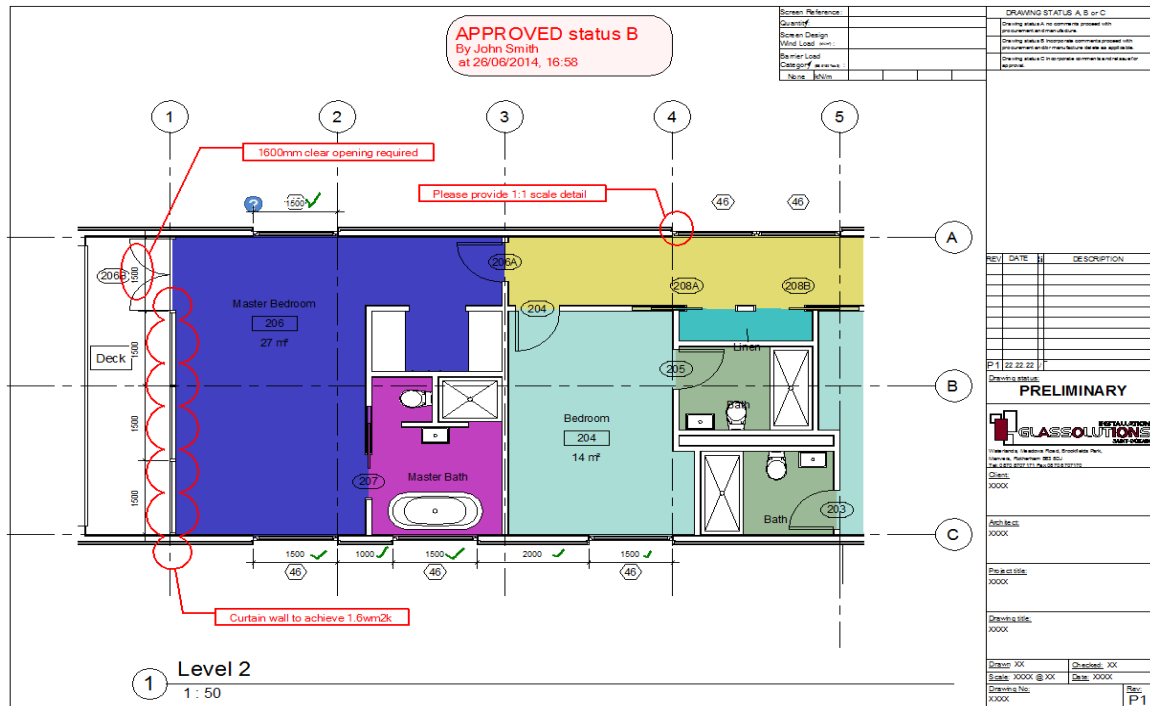


Figure 5.7: Autodesk design review

Using 3D design review tools in conjunction with the BIM model is considerably more efficient than the 2D paper-based approach. During the collaboration process it is suggested that more insightful questions will be asked that will help resolve and address problems early in the process due to the enhanced visibility of details and interfaces, this will potentially save time, improve quality and cost. It is argued that design review software such as Navisworks and Autodesk design review will revolutionise the way design teams approach the design review and approval process, and will help drive better collaboration amongst project design teams resulting in a more streamlined process.

To facilitate BIM implementation in terms of people processes and technology, chapter 6 provides a toward reference BIM execution plan for the façade design process.

## 6 Towards a reference BIM execution plan for the façade design process

Objective 7 of this research was to develop a BEP to help guide the project team through the façade design process when implementing BIM to ensure that the set BIM goals and deliverables for the project are met.

The BEP has been developed in accordance with the findings from this research which demonstrated the need for a BEP prior to the initiation of any BIM project. The BEP is designed to provide a basic platform to facilitate successful BIM adoption into the workplace, and provides basic instructions and examples to assist with the completion of the BEP which can be modified to suit project specific requirements.

It is anticipated that this BEP will help façade contractor's kick-start their BIM adoption journey and will help with the transition to collaborative 3D BIM.

### 6.1 Introduction to the execution plan

This document forms part of the façade design BIM protocol which should be completed by the relevant project team members before the creation of any project related BIM data. The execution plan should be incorporated into the contractual documents and should be used to define how BIM and the design process is to be managed, coordinated and implemented on the project in order to maximise effectiveness and efficiency of the project team throughout the design process.

The BEP should be used as a reference source for all members of the project team and should clearly state which BIM standards are to be utilised for the design process. It should also clearly explain the project specific protocols, data exchange strategy, expected level of detail, roles and responsibilities etc. that has been agreed for the project.

The use of BIM will be implemented to varying extents across different projects, the BEP should be completed on a project specific basis to outline exactly how BIM principles should be applied to the project and at which work stage they should be used.

This plan should be reviewed at regular intervals by the appointed design manager working on behalf of the façade contractor, the BIM Coordinator and the Project Leader to ensure that it always remains consistent with the agreed principles for the project.

Software requirements, appropriate formats for data exchange in the CDE should be clearly defined and agreed in this document. Secondary software files e.g. sketches, drawings, images schedules and other documentation should also be uploaded to the CDE and sufficiently documented in order to store and track the history of file/data exchange between the key stakeholders on the project.

A project specific quality control strategy should be defined and incorporated in the BEP which must be adhered to by each project team member responsible for creating a BIM model for the project. The BIM lead from each discipline should be responsible for ensuring that the key quality control measures are followed throughout the design process.

## 6.2 Project Summary

This should be completed by the façade contractor providing a general overview of the project in terms of the primary function of the building or facility (i.e. office block, living accommodation etc.), location, number of floors and an overview of the façade contractor's scope of work.

### **Project summary:**

- *High quality new build 10 storey office block with retail and restaurant space on the ground floor*
- *Building is located in the centre of Newcastle city centre at the North end of Neville street*
- *North, east, south elevations comprise floor to ceiling glazing using a Schuco FW60+ curtain wall system complete with 150mmmm deep external caps.*

## 6.3 BIM goals, uses objectives and deliverables

This should be specified by the employer to clearly outline the goals, objectives and deliverables of the implementation of BIM for the project.

**BIM goals, objectives and deliverables:**

*The initial concept for the scheme will be developed outside of the BIM environment. The primary uses of BIM software on this scheme will be for developing the design and allowing collaborative design between Glassolutions, DLA architects and clear structures who will also be utilising BIM Software for the Structural, architectural and façade elements of the scheme.*

*Each profession will develop their individual models, these will be shared at regular intervals, currently agreed to be a weekly model issue. The native models will be federated for clash detection, design development and to facilitate a collaborative and coordinated design process.*

The table below should contain the typical uses for the BIM model at each stage of the project lifecycle in accordance with the RIBA stages of work. This should clearly defined by the employer.

RIBA stage-0	RIBA stage-1	RIBA stage-2	RIBA stage-3	RIBA stage-4	RIBA stage-5	RIBA stage-6	RIBA stage7
		Site model	Clash detection	approval drawings			
		Structural design	Design review	Detail design			
		Concept model	Federate models	Federate models			

0	1	2	3	4	5	6	7
Strategic Definition	Preparation and Brief	Concept Design	Developed Design	Technical Design	Construction	Handover and Close Out	In Use



#### 6.4 Project standards to be utilised

This project is to be modelled based upon the following standards and protocols for BIM. Please note that this is not an exhaustive list and should not include standards that the actual building should comply with, for example the Building Regulations

<p><b>Project standards:</b></p> <ul style="list-style-type: none"> <li>- PAS1192-2-2013</li> <li>- AEC BIM standards</li> <li>-</li> </ul>
---

#### 6.5 Roles and responsibilities

The roles and responsibilities should be clearly defined in the BEP and should be in accordance with the recommended key roles as outlined in PAS1192-2 (2013).

Company Name	Primary contact	Role/responsibility
<i>DLA architects</i>	<a href="mailto:davidsmith@dla.com">davidsmith@dla.com</a> Tel:0191 514 7694	<i>Lead designer</i>
<i>Mace</i>	<a href="mailto:deansmith@mace.com">deansmith@mace.com</a> Tel:020 980 777	<i>Interface manager</i>
<i>Glassolutions</i>	<a href="mailto:davidscott@glassolution.com">davidscott@glassolution.com</a> Tel:0768 980888	<i>Task team manager (façade package)</i>
<i>Mace</i>	<a href="mailto:chrissmit@clear.com">chrissmit@clear.com</a> Tel:0191 7998888	<i>Information originator</i>
		<i>Information manager</i>
		<i>BIM manager</i>
		<i>Project deliver manager</i>

Prior to the commencement of any modelling for the project, it should be agreed who has responsibility for the management of the building model at each project phase. This management of the model may change throughout the project as different stages are reached. It is quite common for the lead designer to take the responsibility of managing the model at each stage, however depending on the project certain responsibilities may lie with the client, main contractor or specialist contractor.

The general duties relating to this management role are outlined below and will usually be carried out by the managing party's nominated BIM Coordinator. The BIM Coordinator will be responsible for the following:

- Manage access rights to the CDE
- Record, document, certify and log incoming models
- Check that received models are complete, usable and comply with the protocols
- Federate models and enable design team collaboration to commence
- Perform clash detection in accordance with the protocols and issue Clash detection Reports at the defined intervals
- Maintain model archives and backups.

Where any party identifies conflicts in the Model during any phase of the project, they should promptly inform the model manager. The Model manager should then act promptly to mitigate the conflict.

## **6.6 Model delivery schedule of information exchange**

This section should outline how information is to be shared between all parties working together on the project. If information is to be shared 'live' through an extranet or cloud environment, the key personnel should be provided with a protocol by the employer defining requirements for data management, exchange protocol, login details etc.

If data exchange is to be based on issuing the building model at regular intervals, i.e. every Friday or at the end of each work stage this should be specified by the employer and noted in the model delivery schedule as below.

It is important that the exchange formats are defined by the employer to ensure that the federated models can be interpreted and federated by the appointed person(s). Any secondary software to be utilised in conjunction with the primary BIM software for design intent sketches or design detailing should be specified by the specialist contractor.

<b>Model delivery schedule</b>						
<b>Company</b>	<b>location</b>	<b>Frequency</b>	<b>software</b>	<b>Version</b>	<b>File exchange type</b>	<b>Secondary software</b>
<i>GS</i>	<i>4projects</i>	<i>Weekly/Fri</i>	<i>Revit</i>	<i>2014</i>	<i>IFC/ RVT</i>	<i>Autocad-2014 &amp; Sketchup pro</i>
<i>DLA</i>	<i>4projects</i>	<i>Weekly/Fri</i>	<i>Revit</i>	<i>2013</i>	<i>IFC/ RVT</i>	<i>Autocad-2014</i>
<i>CS</i>	<i>4projects</i>	<i>Weekly/Fri</i>	<i>Tekla</i>	<i>2014</i>	<i>IFC</i>	<i>Autocad-2014</i>
<p><b>NOTES:</b></p> <ul style="list-style-type: none"> <li>➤ <i>Primary software-Revit Architecture 2014 for façade and architectural modelling based on Design Team Meeting on 25 November</i></li> <li>➤ <i>Navisworks and Autodesk design review will be used for the approval process, clash detection and design coordination.</i></li> <li>➤ <i>Structural model - Telka</i></li> <li>➤ <i>Construction document management software – 4 Projects</i></li> </ul>						

## 6.7 Collaboration process

It is recommended that the collaboration process is set up to follow the AEC (UK) BIM standard as shown in fig-6.1.

All design team members will have a 'work in progress model' and 'shared models. Work in progress corresponds to the models worked on within each design team (architectural, MEP, or structural), and shared corresponds to models that are shared between the key stakeholders. The work in progress models will link to the shared models from other

stakeholders; these shared models will then be updated on a regular basis in accordance with the agreed information exchange schedule.

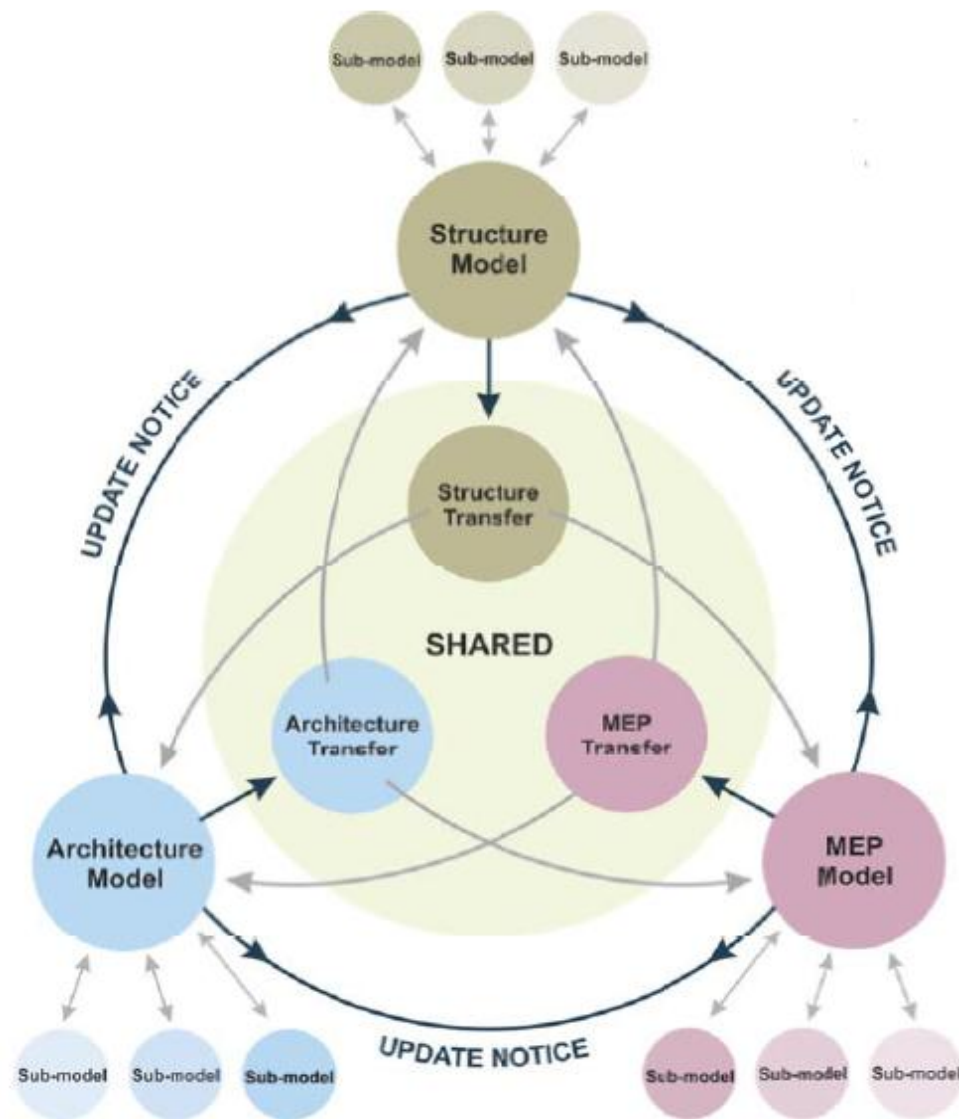


Figure 6.1: AEC (UK) BIM standard CDE, 2012.

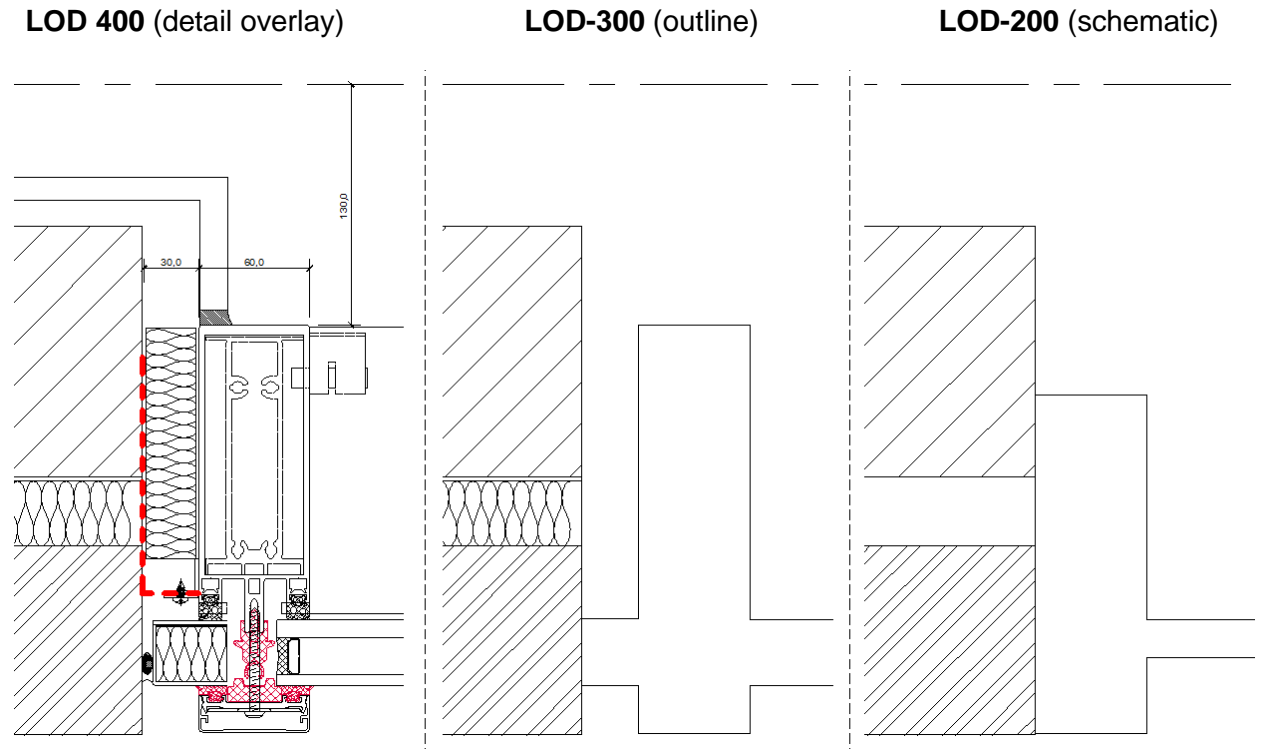
The collaboration and coordination process should be attended by the relevant team members who have the appropriate knowledge and the expertise about their works package and have the skills to work and navigate in the BIM environment. The BIM coordination meeting should only include the relevant people directly involved with the element of works that requires coordination. Adequate time should be allocated for design intent sketches in order to develop and refine the design prior to detail modelling. The sketches should be also uploaded to the CDE to store and track the history of the design development. The following table should be completed and agreed with the employer and

should be in line with the project programme. The 'week/date' section can be changed to highlight milestones during the design process.

<b>Façade collaboration schedule</b>						
<b>Week / date</b>	<b>Attendees required</b>	<b>Design intent phase</b>	<b>Production of 3d model</b>	<b>Clash detection</b>	<b>Comment / approval</b>	<b>Model status S2-S5</b>
<b>Week-1</b>	<i>Team-1,3</i>	✓			✓	S2
<b>Week-2</b>	<i>Team-1,3</i>	✓	✓		✓	S2
<b>Week-3</b>	<i>Team-1,3 &amp;4</i>	✓	✓		✓	S2
<b>Week-5</b>	<i>Team-1,3</i>		✓	✓		S3
<b>Week-8</b>	<i>Team-1,3&amp;5</i>		✓	✓	✓	S4
<p><b>NOTES:</b></p> <ul style="list-style-type: none"> <li>➤ Status S2 –LOD-200</li> <li>➤ Status S3–LOD-300</li> <li>➤ Status S4–LOD-400</li> <li>➤ e.g. Team-1 –Architectural , team 2 – structural , team 3- façade contractor</li> <li>➤ The above collaboration schedule should be aligned with the project programme</li> </ul>						

## 6.8 Levels of detail / development

For the façade design process it is recommended that the level of detail development is split up into 3 stages as illustrated below:



**LOD 200** (schematic) is the process of applying approximate information in terms of sizes, shape, and location.

**LOD 300** (outline stage) should include accurate shape, quantity, size, orientation and location of the façade components.

**LOD 400** should include the necessary level of detail for façade design interfaces using the 2D overlay principle in order to keep the model to a manageable size. The model should include accurate information showing specific façade components and the strategy for achieving appropriate thermal and weathering requirements, it should also provide specific dimensions showing the general setting out of the façade elements from the structure or gridline. The model at this stage should be suitable to allow the lead designer to provide signoff/approval of the model to allow the façade contractor to commence with procurement and manufacture.

It is important the LOD development for each stage of the design process is clearly understood by the project team, and should be noted in the façade works collaboration schedule to help manage expectations.

## 6.9 Model naming conventions

Below is a basic model naming structure for the CDE. This can be adjusted to suit the project requirements if necessary.



E.g.: **GS-VSL-S3-WIP**

- **Originator** – who is the creator of the model file, e.g:
  - DLA - DLA architects
  - GS – Glassolutions (façade contractor)
  - CS – Clear structures (structural engineer)
- **Project code** – Name of building or facility defined by the employer e.g:
  - VSL – Victoria street London
- **Model status** – The current status of the model being issued:
  - Status S2 - Information –LOD-200
  - Status S3 – Set out approval –LOD-300
  - Status S4 – Detail approval –LOD-400
  - Status S5 – Construction issue –LOD-400
- **Shared/WIP** - The end of the file name should highlight if the model is a work in progress issue for information only, or if it has been issued for the collaborative environment.

### 6.10 Quality control strategy

Each design team producing a model should be responsible for the quality of their model in terms of consistency in the alignment with the project standards, and the efficiency of how the model performs. The BIM lead on behalf of each discipline should ensure that the following quality control points are regularly addressed:

<b>BIM Quality control checks</b>			
<b>Checks</b>	<b>Responsible</b>	<b>Frequency</b>	<b>Complete</b>
File/model size should not exceed 100mb	Design leader GS	Continues	✓ -21/01/14 ✓ -21/02/14
Annotation to follow AEC (UK) BIM standards (text, line weights, dimension styles etc	Design leader GS	After every Shared Mode Update & Continuous	✓ -21/01/14 ✓ -21/02/14
Use agreed drawing title block sheets			
Purge unused elements in the model such as unused families, line styles etc			
Minimise the number views (plans, elevations, sections, schedules etc.) and remove unused views			



Lengths to be measured in millimetres to 1 decimal place	Design leader GS	Continues	
Visual check – ensure that there are no unintended model components and the design intent has been followed	Design leader GS	After every Shared Mode Update	
Interference check – detect problems in the model where components are clashing	Design leader GS	After every Shared Mode Update	
Performance check – Check the performance of the model and consider ways to reduce model size to increase model speed and performance.	Design leader GS	Continues	

The BIM lead from each team should be responsible for running regular checks to achieve the points above. By accomplishing these checks, it enables a more efficient collaboration between all project models and provides a strong base point to initiate interference checks and clash detection.

### 6.11 Project datum /coordinates

All project BIM models created should be positioned in accordance with a specific project coordinate system and datum to ensure that the correct alignment is maintained for all shared models. The shared coordinates should be specified by the lead designer at the beginning of the project.

Example:

- Level 0, gridline intersection A-9
- North/south = 540633019.8

- East/west =5010344015.3
- Angle to true north = 4.27833°
- Level = +33.476m

## **6.12 Design approval process**

The approval of façade interfaces to allow procurement and manufacture to commence should not differ to any great degree from the traditional process. The big room collaboration meeting should always produce a set of actions to allow the native models to be developed and updated in accordance with comments and discussions made during the collaboration meeting.

During model issue stages S2 and S3, the model should be marked up with comments using the redline tool in Navisworks and loaded into the CDE by the document controller to keep track record of the design development. Comments should also be recorded in writing and distributed as part of the meeting minutes.

The S3 model issue will normally consist of more detail design therefore more 2D drawings can be extracted from the model, with this in mind it is recommended that a 2D design review software is used such as Autodesk design review to allow the lead designer to mark-up, comment and issue to the façade contractor with the relevant status (A, B, C). The marked up drawings should be loaded into the CDE by the document controller in order to keep a track record of the design development.

## **6.13 Training**

Training of staff within a design team must be a continuous process and especially during the early stages of BIM adoption. As well as inducting new members of the team, training should include advanced BIM training and expert BIM mentoring occurring at critical phases of the project to suit the design programme. A project induction outlining the collaborative methodology and process workflow should be given to all new staff joining the project design team including package leaders and project managers.

## 7 Discussion

The first and most important step towards successfully adoption BIM is to establish what it actually means. In many publications BIM is described as a single model which has confused many people, it is important to understand that level 2 BIM is not a single model, it is a series of interconnecting or federated models to allow information to be extracted and shared. Lack of understanding is a common statement found in many industry surveys and publications which is understandable as BIM is a new development, however people in the industry need to use their own initiative in order to understand and begin the transition to BIM. The findings from this research has demonstrated that the key starting point for the implementation of BIM is to appoint a BIM champion within a business to lead the transition in order to address the key technical, social and process related challenges:

- Defining level 2 BIM
- Strategy and vision
- Realigning existing processes
- Cultural changes
- Design execution plan
- Software training (tailored to suit specialist trade)

PAS 1192:2 is arguably the top guidance document for the implementation of level 2 BIM. Initially this document is difficult to understand as it is a reference document written by experts for people with BIM knowledge and experience, it is not designed for the inexperienced; however once you get past the common language and BIM terminology things start to become much clearer. In terms of the design process things are not all that different from the traditional workflow, the basic principles of design review, roles and responsibilities, design approval etc. should not change to any great degree.

To master BIM implementation for the façade design process it is important to learn and understand the capabilities and limitations of the BIM software otherwise known as the 'oxygen of BIM'. The industry consensus with regards to BIM software is that is not appropriate for façade design and is unable to achieve the LOD for façade interfaces. Following the computer based study in chapter 4 and through personnel communications

with experienced Revit users; it is evident that there are ways to achieve greater LOD using BIM software but requires a different approach and a different mind-set.

The main problems during construction are predominantly design errors caused by lack of coordination with other trades, and due to the lack of understanding of how certain building interfaces are to be constructed. BIM will not cure all evils but will allow you to work smarter, and will significantly help towards reducing the common problems experienced during design and construction.

## **7.1 Areas of opportunity:**

### **Sustainability:**

As BIM is perceived to create an overall better and more efficient product, removing the barriers of BIM and utilising it even if it is not a contractual requirement, will lead to better business opportunities, promote a company's efficiency and will promote a more sustainable approach to the façade design process and beyond. This research provides a baseline document for the implementation of BIM, and will give people in the façade industry the confidence to engage with clients to discuss BIM requirements, manage expectations and to offer guidance on how to utilise BIM successfully for the façade design process.

### **Social benefit:**

BIM is set to change the way project teams perform and work together by promoting a more integrated design process. This will bring more social and cultural benefits which will help improve working relationships, and will help cut out the 'blame culture' as problems will be identified and resolved as a team during the design process as opposed to on the construction site.

## **7.2 Limitations to work**

The content of this research does not consider the information side of BIM, procurement methods, the manufacturing process and how these key façade related processes that occur prior to construction will coincide with the facade design process. As BIM demand and adoption is still at a low level in the façade industry, it has not been possible to test the execution plan in order to measure its effectiveness, it is anticipated that in the next 12-18 months an opportunity will present itself.

## 8 Conclusion

Research Objectives	Conclusion
<p>1. Clarify the goals and anticipated benefits of BIM.</p>	<p>BIM goals are to increase the efficiency of the AEC industry by promoting integrated project delivery. In many publications it is anticipated the BIM will unlock new and more efficient ways of working and is set to revolutionise project delivery in the UK.</p> <p>BIM has many benefits as highlighted in this research, the 3 main benefits for the façade industry are:</p> <ul style="list-style-type: none"><li>• BIM promotes early involvement of specialist contractors</li><li>• Provides better visualisation</li><li>• Promotes a more streamlined design and collaboration process</li></ul>
<p>2. Examine the current adoption levels of BIM in the construction industry.</p>	<p>BIM software such as Revit has been specifically designed for architects, and provides them with clear ROI which is the reason why adoption levels are high in architectural practices.</p> <p>Main contractors are on board with BIM and adoption levels are growing due to client demand and many new projects in the UK are being awarded based on BIM capability.</p> <p>BIM in the façade industry has not yet taken off and adoption levels are still at 0% due the barriers that surround BIM.</p>

<p><b>3.</b> Review and asses the barriers of BIM in the construction industry.</p>	<p>The main barriers of BIM in the façade industry can be defined as follows:</p> <ul style="list-style-type: none"> <li>• Learning and understanding BIM software/hardware.</li> <li>• Lack of expertise with regards to BIM and its processes.</li> <li>• Current project time scales are not set up for BIM.</li> <li>• There is no clear protocol for the façade industry.</li> </ul>
<p><b>4:</b> Establish the appropriate level of detail for façade design when using BIM enabled software.</p>	<p>The implementation of BIM should not change the required level of detail for façade design. The level of detail currently utilised for the 2D work flow can also be applied to the 3D environment by using the 2D detail overlay approach.</p>
<p><b>5.</b> Examine the capabilities of BIM enabled software.</p>	<p>The analysis of BIM enabled software undertaken in chapter 4 demonstrated that Revit is capable of producing an acceptable level of detail for façade design, but requires a different approach compared to the 2D workflow. It is important to note that the focus of this research was based on uncomplicated window, door and curtain wall details; more research is required in order to establish if the software is capable of producing more complex details and geometry. Another key finding was the interchangeable door/window families which are similar to the dynamic blocks in AutoCad, which allow quick and easy changes to be made to geometry of the 3D components to facilitate different design and site conditions. Once BIM becomes more common in the facade industry and adoption levels increase, It is anticipated that more intelligent families will be developed by façade contractors and system suppliers to facilitate façade design detailing in the 3D environment.</p>

<p>6. Examine the transition from 2D to 3D design.</p>	<p>To ensure a successful transition to 3D BIM, it is important to consider the following key factors:</p> <ol style="list-style-type: none"><li>1. <b>People</b> need to embrace BIM as a positive change to the industry, and should work together to develop this new process to create a better and more collaborative design process.</li><li>2. <b>Processes</b> need to be defined, developed and put in place for BIM implementation and could be the difference between failure and successful BIM execution.</li><li>3. <b>Technology</b> and BIM tools have been developed to facilitate a more effective collaboration process and will provide better interoperability of the project information at each stage of the construction lifecycle. Web based CDE's are also being developed in line with BIM processes to allow multidisciplinary teams to share and record information in a structured way.</li></ol>
<p>7. Develop a BIM execution plan to improve the façade design process.</p>	<p>The BEP developed in chapter 6 is designed to provide a basic platform to facilitate successful BIM implementation and can be modified to suit project specific requirements. As BIM knowledge is currently at a low level in the façade industry, the BEP provides basic instructions, examples and recommendations to assist with the completion of the BEP. It is anticipated that not only will the execution plan provide a structured approach to BIM implementation for the façade design process; it will also increase the level of understanding of the BIM workflow and provide a foundational framework for its execution.</p>

## 8.1 Recommendations for future Work

This research has identified areas where further research is required for the implementation of BIM:

- **Autodesk Revit capabilities**

Research is required on the capabilities of the BIM software to facilitate more complex geometry.

- **Façade Revit families.**

Research is required on the creation of dynamic Revit families for façade components.

- **The 'I' in BIM**

Further research required on the information side of BIM in conjunction with the façade design workflow.

- **Procurement and manufacture**

Research required on how the facade procurement and manufacturing process for BIM will be executed and how this will work in conjunction with the façade design process.



## References

### Websites

Accuracy and aesthetic, 2008. Visualisation (online). Image available from:

<http://accuracyandaesthetics.com/?p=833> (Accessed 26th Aug 2014).

Aeccafe blogs, 2013. Model coordination and clash detection (online). Image available from: <http://www10.aeccafe.com/blogs/aeccafevoice/2013/05/16/new-version-of-autodesk-bim-360-glue-provides-greater-access-to-project-information/> (Accessed 26th

Aug 2014).

Architectural evangelist, nd. Top 7 reasons to use Revit software (online). Available from:

<http://www.architecturelevangelist.com/tips-and-tricks/top-7-reasons-to-use-revit.html>

(Accessed 08th June 2014).

Autodesk (nd), Navisworks Overview (online). Available from: Brochurehttp

[http://www.synergis.com/uploads/resources/autodesk\\_navisworks\\_overview\\_brochure\\_us.pdf](http://www.synergis.com/uploads/resources/autodesk_navisworks_overview_brochure_us.pdf) (Accessed 26th June 2014)

Autodesk Revit, nd. Building design and construction software, (online) Available from:

<http://www.autodesk.co.uk/products/autodesk-revit-family/overview> (Accessed 08th June 2014)

ANGL consulting, 2014. The greatest risk to BIM adoption, (online). Available from:

<http://anglconsulting.com/greatest-risk/> (Accessed 08th June 2014).

Aubi F, 2011. Detailing in Autodesk Revit Architecture (online). Available from:

[http://paulaubin.com/downloads/2011\\_AU/Papers/AB3744\\_Aubin\\_Details.pdf](http://paulaubin.com/downloads/2011_AU/Papers/AB3744_Aubin_Details.pdf) (Accessed 31th Aug 2014).

BIM models overview, 2014 (online). Available from:

[http://www.kawneer.com/kawneer/north\\_america/en/bim.asp](http://www.kawneer.com/kawneer/north_america/en/bim.asp) (Accessed 07th May 2014).

BIM Guide Measure B Bond (nd) College of the desert (online). Available from:

<http://codbond.eispro.com/uploads/20110224%20College%20of%20the%20Desert%20BIM%20Guide.pdf> (Accessed 22th June 2014)

Bexel Consulting, nd. Virtual Design and Construction (online).Image Available from:

<http://www.bexelconsulting.com/technology/VDCBIM.aspx> (Accessed 16th March 2014).

BIM task group, 2013 (online). Available from: <http://www.bimtaskgroup.org/> (Accessed 08th June 2014).

BIM task group, 2013. Frequently asked questions (online). Available from: <http://www.bimtaskgroup.org/bim-faqs/> (Accessed 08th June 2014).

Barista D (2014). 7 ways to cut waste in BIM implementation (online). Available from: <http://www.bdcnetwork.com/7-ways-cut-waste-bim-implementation> (Accessed 22th June 2014)

Connaughton J, 2011. CIOB newsletter (online). Available from: <http://www.construction-manager.co.uk/news/bim-cost-4m-could-save-billions/> (Accessed 07th May 2014).

Digital think box, 2013. Level 2 work shop (online). Available from: <http://rebeccadecicco.blogspot.com.au/2013/08/level-2-live-workshop.html> (Accessed 26th May 2014).

D/C/CAD, 2009. The 10 Worst Things You Can Do In Revit (online). Available from: <http://www.dccadd.net/papers/The%20Top%2010%20Worst%20Things%20You%20Can%20Do%20In%20Revit.pdf> (Accessed 08th June 2014)

DPR construction (2012) Making the Integrated Big Room Better (online). Available from: <http://www.dpr.com/assets/docs/Big-Room-Whitepaper.pdf> (Accessed 22th June 2014)

David Philp (nd) H.M. Government's whole sector approach to implementation of digital, collaborative working (online). Available from: [http://www.convr2013.com/keynote/David\\_Philp\\_CONVR.pdf](http://www.convr2013.com/keynote/David_Philp_CONVR.pdf) (Accessed 22th June 2014)

Hamil S, 2013. Construction code, BIM tool market share (online). Available from: <http://constructioncode.blogspot.co.uk/2013/01/bim-objects-from-manufacturers.html> (Accessed 08th June 2014).

Knight A, 2013. 4 barriers to BIM adoption, (online). Available from: <http://www.builderonline.com/technology/4-barriers-to-bim-adoption.aspx> (Accessed 08th June 2014).

Mcphee A, 2012. Practical BIM (online). Available from: <http://practicalbim.blogspot.com/2012/10/too-much-detail-why-is-my-computer-so.html> (Accessed 31th Aug 2014).

Reaping the Benefits of BIM – An Interview with David Philp, 2013. (Online) Available from: <http://www.cadvantage.co.uk/reaping-the-benefits-of-bim-an-interview-with-david-philp/> (Accessed 08th June 2014).

Structure magazine, 2013. Big room collaboration (online). Image available from: <http://www.structuremag.org/wp-content/uploads/SF-SutterMedical-Aug131.pdf> (Accessed 26th Aug 2014).

Sustain 2014. Analyse and simulate (online). Image available from: <http://sustainmagazine.com/how-bim-computer-modelling-can-help-design-buildings-that-are-sustainable/> (Accessed 26th Aug 2014).

SEC group, 2012. First Steps to BIM Competence (online). Available from: [http://codebim.com/wp-content/uploads/2013/06/BIM\\_Guide\\_for\\_SEC\\_First\\_Steps-REV\\_2.pdf](http://codebim.com/wp-content/uploads/2013/06/BIM_Guide_for_SEC_First_Steps-REV_2.pdf) (Accessed 17th May 2014).

Salman A et al (2008) New Paradigm for Visual Interactive Modelling and Simulation for Construction Projects (online). Available from: <http://www.neduet.edu.pk/Civil/ICCIDCI/Conference%20Proceedings/Papers/045.pdf> (Accessed 22th June 2014)

Thomas E (2013) HMYOI Cookham Wood (online). Available from: [http://www.buildoffsite.com/pdf/publications/BoS\\_CookhamWood.pdf](http://www.buildoffsite.com/pdf/publications/BoS_CookhamWood.pdf) (Accessed 26th June 2014)

The NFB, BIM-readiness survey, 2012 (online). Available from: [http://www.builders.org.uk/resources/nfb/000/318/333/NFB\\_BIM\\_Survey\\_BIM-ready\\_or\\_not.pdf](http://www.builders.org.uk/resources/nfb/000/318/333/NFB_BIM_Survey_BIM-ready_or_not.pdf) (Accessed 07th May 2014).

The NFB, BIM-readiness survey, 2013 (online). Available from: [http://www.builders.org.uk/resources/nfb/000/325/156/BIM\\_Survey\\_Report\\_2013.pdf](http://www.builders.org.uk/resources/nfb/000/325/156/BIM_Survey_Report_2013.pdf) (Accessed 07th May 2014).

The NBS, National BIM survey, 2013 (online). Available from: <http://www.thenbs.com/pdfs/NBS-NationlBIMReport2013-single.pdf> (Accessed 07th May 2014).

Undom K, 2012. NBS and Kennedy LLP legal counsels' breakfast meeting on BIM legal issues (online). Available from: <http://www.thenbs.com/topics/bim/articles/legalCounsels-BreakfastMeeting.asp> (Accessed 26th June 2014).

Walker C, 2011. CIOB newsletter (online). Available from: <http://www.construction-manager.co.uk/news/why-governments-bim-strategy-doesnt-go-far-enough/> (Accessed 07th May 2014).

4projects (nd) BIM4BIM project (online). Available from <http://www.4projects.com/OurCompany/BIMCascade.aspx> (Accessed 22th June 2014)

### **Journals**

Azhar S , 2011. Leadership & Management in Engineering. 11 (3), pp.241-252.

Bilal S, 2009. Building information modelling framework: A research and delivery foundation for industry stakeholders. 18 (3), pp. 357-375.

Bynum, Patrick; Issa, Raja R. A.; Olbina, Svetlana, 2013. Journal of Construction Engineering & Management. 139 (1), pp.24-34.

Elmualim A & Gilder J, 2014. BIM: innovation in design management, influence and challenges of implementation, Architectural Engineering and Design Management, 10 (3-4), pp.183-199

Gu, N, & London, K, 2010. Understanding and facilitating BIM adoption in the AEC industry. 19 (8), pp. 988-999.

Leite F, Akcamete, A, Akinci, B, Atasoy, G, Kiziltas S, 2011. Analysis of modeling effort and impact of different levels of detail in building information models. 20(5), pp. 601-609.

Lindner, F., Wald, A, 2011. Success factors of knowledge management in temporary organizations. 29 (7), pp.877–888.

Lu, W, Peng Y, Shen Q, Li, H, 2012. Generic model for measuring benefits of BIM as a learning tool in construction tasks. Journal of Construction Engineering and Management. 139 (2), pp. 195-203.

Merschbrock, Christoph; Munkvold, Bjørn, Erik, 2012. Communications of the Association for Information Systems. 31 (10) pp.207-228.

Park, Hyoung-June, 2008. Evolution+ BIM: The utilization of building information modelling at an early design stage. pp.552-559.

Porwal, A & Hewage, K. N, 2013. Building Information Modeling (BIM) partnering framework for public construction projects. 31, pp. 204-214.

Schade J , Olofssona T, Schreyer M, 2011. Decision-making in a model-based design process. 29 (4), pp.371-382.

Sebastian, R, 2011. Changing roles of the clients, architects and contractors through BIM. 18 (2), pp.176–187.

Volk R, Stengel J, Schultmann F, 2013. Building Information Modeling (BIM) for existing buildings - Literature review and future needs. 38, pp.109–127.

Wong K, Fan Q, 2013. Building information modelling (BIM) for sustainable building design. 31 (3/4) pp.138 – 157.

Yan H, Damian P, 2008. Benefits and barriers of building information modelling conference on Computing in Civil and Building. 85(17), pp.179.95.

### **Reports**

AEC (UK) BIM Protocol, 2012. Implementing UK BIM Standards for the Architectural, Engineering and Construction industry. Version 2.0.

BIM Industry Working Group, 2011. Building Information Modelling (BIM) Working Party Strategy Paper: London.

BS ISO 16739:2013. Industry Foundation Classes (IFC) for data sharing in the construction and facility management industries. BSI

Cabinet Office, 2011. Government Construction Strategy: London.

PAS 1192-2:2013. Specification for information management for the capital/deliver phase of construction projects using building information modelling. BSI.

Sinclair, D, 2012. BIM Overlay to the RIBA Outline Plan of Work, London, Royal Institute of British Architects Publishing.

## **Books**

Barnes and Davies, 2014. BIM in principle and practice. London: ICE publishing.

Krygiel E, Dzambazova T, Demchak G, 2009. Introducing Revit Architecture 2009: BIM for Beginners. Indianapolis: Wiley publishing.

Naoum S.G, 1998. Dissertation research and writing for construction students. Oxford: Elsevier publishing.

## 9 Appendices

### 9.1 Appendix 1: Mace façade/BIM supply chain workshop comments

- *There is never enough information at tender stage to allow BIM to priced accurately, a standard BIM protocol and execution plan is needed”*
- *Specialist contractors are always appointed too late, to enable BIM to be effective this needs to be addresses”*
- *Clients, architects, main contracts and specialist contractors all have different requirements for BIM and have different views on what is good for”*
- *How will the collaborative / contractual approach work on level 2 BIM projects”*
- *“It is anticipated that BIM will save on design costs, however as it is not yet fully understood, contractors are actually increasing their tender prices to cover the 2d and 3d aspects of design process”*
- *In current practice, drawings which are submitted by the specialist contractor are given an approval status, when we issue a 3d model how will this be approved? There is no process in place for this”.*
- *“With regards to the level of detail in the 3d model, Autodesk Revit is not set up for the level detail required for façade design, it is not sophisticated enough”.*
- *We have experienced compatibility issues when sharing and combining models with other trades”.*
- *Revit is good for visualisation, but not appropriate for finite detail required for the building envelope interfaces”*

## 9.2 Appendix 2: Email survey - level of detail for BIM

**Birrell, Danny**

**From:** Birrell, Danny

**Sent:** 09 June 2014 17:14

**Subject:** Appropriate level of detail for BIM

**Attachments:** BIM Detail survey.docx

Good afternoon

I recently attended a façade supply chain meeting at the Mace headquarters along with your good selves, the discussions with regards to BIM were certainly interesting however the key question still remains unanswered, how will BIM and façade design will work considering the complexity of modern day facades, and the level of detail required for façade interfaces. I'm currently studying at Bath university and I'm in the process of writing a dissertation on BIM, my working title is:

[A research and delivery foundation for the facade design process utilising building Information modelling.](#)

As part of the dissertation, I am attempting to develop a protocol to outline the appropriate level of detail for façade design when using BIM enabled software, I would be very gratefully if you could take a look at the attached and select the 2 details you think are an acceptable level of detail and then email the document back. Also just a couple of quick questions:

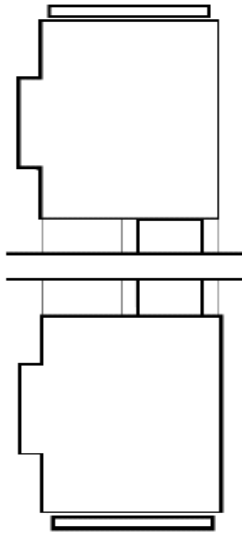
1. Do you think BIM software is appropriate for façade design?
2. What do you think is required the most to enable façade contractors to successfully adopt BIM?

If you can spare a minute of your time to do this it would be very much appreciated, the survey results are for research purposes only. Thank you in advance

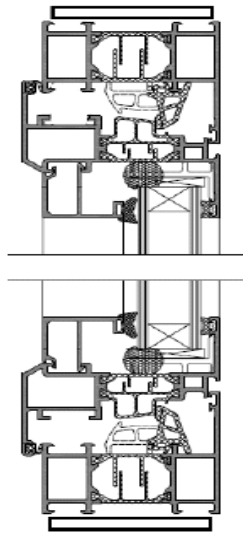
Kind Regards

**Danny Birrell**

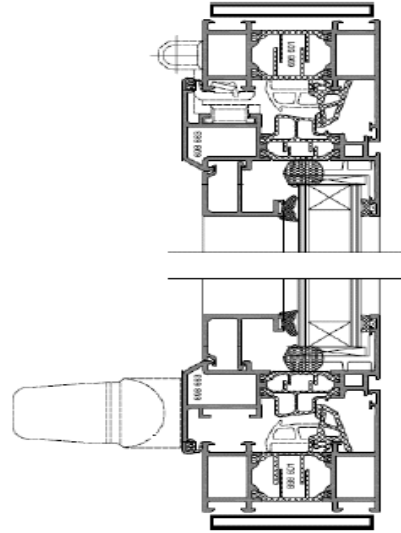




Low resolution



Medium resolution



High resolution

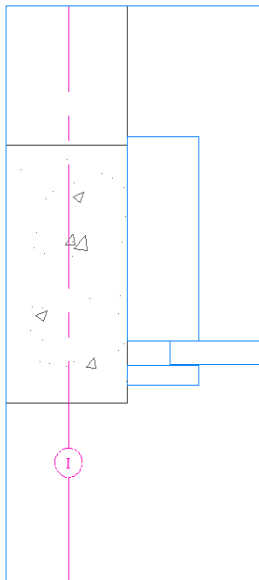
Please select the appropriate box

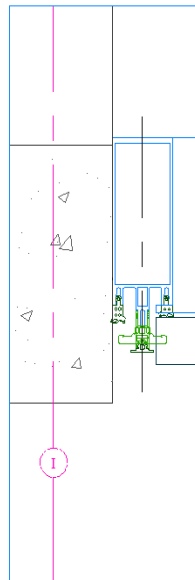
Detail -1

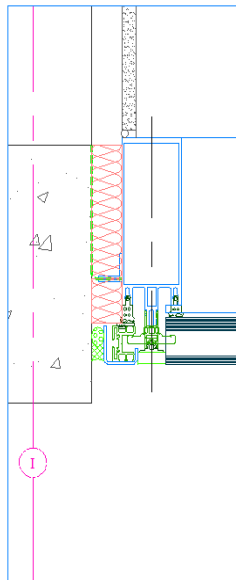
Detail-2

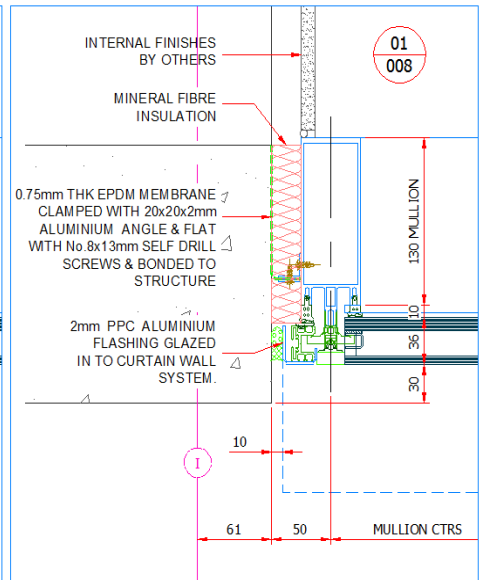
Detail-3

Detail-4










Please select the appropriate box

**Birrell, Danny**

**From:** Richard Menhennet <rm@fendor.co.uk>

**Sent:** 11 June 2014 14:29

**To:** Birrell, Danny

**Cc:** Phil

**Subject:** RE: Appropriate level of detail for BIM

**Attachments:** BIM Detail survey.docx

Afternoon Danny,  
Please find attached questionnaire.

1. BIM Software in principal could be a great help in Facade design. This would be dependent on the detail and input from all other trades and the simplicity to create and upload Facades to the model. Clashes and interface issues could be made clear well before manufacture & installation. The main concern would be retraining of Staff, and the associated costs with software.

2. All other trades would need to sign up to BIM principal, free or very low cost software. It may be very worthwhile if the model reduced the need for separate interface drawings to be produced.

Kind regards,

**Richard Menhennet**

Snr Project Draughtsman

**Fendor Ltd.**

T: + 44 (0) 191 4170170

F: + 44 (0) 191 415 8100

W: [www.fendor.co.uk](http://www.fendor.co.uk)



Pioneers in Specialist Glazing

Fendor Ltd (registered number: 05472268 and Fendor Holdings Ltd (registered number: 05801493) are limited liability companies registered in England and Wales.

Registered office: Spire House, Spire Road, Washington, NE37 3ES, UK.

If you have received this message in error, please notify the originator immediately. If you are not the intended recipient, you should not use, copy, alter, or disclose the contents of

this message. All information or opinions expressed in this message and/or any attachments are those of the author and are not necessarily those of Fendor Holdings Ltd or its

affiliates. Fendor Ltd and Fendor Holdings Ltd accept no responsibility for loss or damage arising from its use, including damage from virus.

Please consider the environment before printing this e-mail

**Birrell, Danny**

**From:** David, Scott

**Sent:** 09 June 2014 17:14

**Subject:** RE: Appropriate level of detail for BIM

**Attachments:** BIM Detail survey.docx

Danny

Please see attached questionnaire.

[Do you think BIM software is appropriate for façade design?](#)

I have used Revit and it is more for architects, I'm not sure at this stage how we can achieve the level of detail for facades using Revit.

[What do you think is required the most to enable façade contractors to successfully adopt BIM?](#)

Training on BIM procedures, software training tailored for façade design

Kind Regards

**David Scott**

**Birrell, Danny**

**From:** Thalhammer Andreas <Andreas.Thalhammer@gig.at>

**Sent:** 11 June 2014 19:48

**To:** Birrell, Danny

**Cc:** Gaigg Jürgen; Reiter Michael

**Subject:** Antw: Appropriate level of detail for BIM

**Attachments:** BIM Detail survey.docx

Dear Danny,

Please find below our responses to your queries:

1. Do you think BIM software is appropriate for façade design?

Basically yes - but the present Project timescales does not allow for a proper development which is one of the main reasons for BIM --> The whole programming of Projects has to be changed. Further it will definitely shortly work very smoothly on standardized cladding/Curtain walling systems - whereas the bespoke, special architectural claddings will struggle with the correct information behind - here we definitely have at present double work and not overall savings.....

2. What do you think is required the most to enable façade contractors to successfully adopt BIM?

As a first step the cladding contractors are required clear examples for a window system, a stick system, a unitized system,..... as guidelines. eg: 3D overall visible envelope combined with 2D "technical" drawings/details.....

I do hope my responses are useful  
best regards from Austria

Andy Thalhammer

ppa Ing. Andreas Thalhammer

Leiter Technik

Head of Technical Department

GIG FASSADEN GmbH

Industriestrasse 30

4800 Attnang-Puchheim

AUSTRIA

Tel.: +43 (0) 7674/602-222

Mail: [andreas.thalhammer@gig.at](mailto:andreas.thalhammer@gig.at) [www.gig.at](http://www.gig.at) FN286499y, LG Wels

**Birrell, Danny**

**From:** Kam Sagoo <Kam.Sagoo@faa-group.co.uk>

**Sent:** 10 June 2014 12:01

**To:** Birrell, Danny

**Cc:** Tarvy Gosal

**Subject:** FW: Appropriate level of detail for BIM

**Attachments:** BIM Detail survey.docx

Daniel,  
Please see below response to your email.  
regards

**Kam Sagoo**

*Design Manager*

Blue Team

**ddi. 01753 505 126/ m. 07507 833 109/ t. 01753 576680 ext 623**

Fleetwood House, 480 Bath Road, Slough, Berks. SL1 6BB

[Kam.Sagoo@faa-group](mailto:Kam.Sagoo@faa-group).

**Fleetwood**

Architectural  
Aluminium

Designed Technical Solutions  
Windows, Doors & Facades



1. Do you think BIM software is appropriate for façade design?

The BIM model is being used successfully throughout the industry. The Riverlight project in Battersea has been developed using BIM & has worked cohesively to determine building performance.

2. What do you think is required the most to enable façade contractors to successfully adopt BIM? - Budget & Time to initiate the systems & software.

**Birrell, Danny**

**From:** John Libby <john.libby@fareastglobal.com>

**Sent:** 13 June 2014 11:08

**To:** Birrell, Danny

**Subject:** RE: Appropriate level of detail for BIM

Hi Danny, see below and attached response to your email

1. [Do you think BIM software is appropriate for façade design?](#)

Simple answer is “yes” but the more difficult part is deciding what to use. Consultants and architects seem to think the more detail the better, but my view is keep data and complexity to a minimum.

2. [What do you think is required the most to enable façade contractors to successfully adopt BIM?](#)

Agreement on what is required. This must be set out at tender stage to enable it to be costed into the project. A clear BIM protocol would be helpful...ideally issued by an independent body such as CWCT.

Good luck with this project. I think everyone has a different understanding of what BIM means at the moment!

Regards,

**John Libby**

Technical Director

**Far East Facade UK Ltd**

A subsidiary of FAR EAST GLOBAL GROUP LTD.

Mobile: +44 7789 410573

[john.libby@fareastglobal.com](mailto:john.libby@fareastglobal.com) | [www.fareastglobal.com](http://www.fareastglobal.com)

Please note our new office address from 2<sup>nd</sup> June 2014 is

1 Great Cumberland Street, London, W1H 7AL, United Kingdom.

### 9.3 Appendix 3: Industry email survey current BIM adoption

**Birrell, Danny**

**Subject:** FW: BIM survey

**From:** Birrell, Danny

**Sent:** 30 April 2014 23:29

**Subject:** BIM survey

Dear all,

I am currently in the process of completing my dissertation for an MSc in Façade Engineering.  
Working title:

*A research and delivery foundation for the facade design process utilising building  
Information modelling*

I would be grateful if you could spare a few moments of your time to complete this short  
questionnaire. Please click on the link below

<http://www.smartsurvey.co.uk/s/111674EEXRL>

**Thank you in advance for taking the time to complete this.**





Kind Regards







**Danny Birrell**

Design Leader




**Glassolutions**





## 1. Page 1






1. Age category				
			Response Percent	Response Total
1	under 18		0.00%	0
2	18-24		2.50%	1
3	25-34		25.00%	10
4	35-54		60.00%	24
5	55+		12.50%	5
			answered	40
			skipped	0




2. How many years of experience do you have in your field? (years)				
			Response Percent	Response Total
1	1-5 years		5.00%	2
2	6-10 years		7.50%	3
3	11-15 years		15.00%	6
4	16-20 years		40.00%	16
5	21-30 years		17.50%	7
6	30 +		15.00%	6
			answered	40
			skipped	0
















4. Who do you work for?				
			Response Percent	Response Total
1	Main contractor		30.00%	12
2	Specialist Contractor		37.50%	15
3	Architectural practice		32.50%	13
4	Consultant		0.00%	0
5	Other (please specify):		0.00%	0
			answered	40
			skipped	0
Answers for: Other (please specify):			0 answers	
No answers found.				









5. Number of people in your organization?				
			Response Percent	Response Total
1	1 to 10		12.50%	5
2	11 to 50		15.00%	6
3	51 to 250		40.00%	16
4	250+		32.50%	13
			answered	40
			skipped	0



6. What is the general level of interest in BIM among clients/ prospects in your marketplace?				
			Response Percent	Response Total
1	None		5.00%	2
2	Low		20.00%	8
3	Medium		52.50%	21
4	High		12.50%	5
5	Very High		10.00%	4
			answered	40
			skipped	0






7. Does your company currently use BIM, or is it intending to use BIM in the near future?					
				Response Percent	Response Total
1	Yes			72.50%	29
2	No			7.50%	3
3	Don't know			20.00%	8
				answered	40
				skipped	0




8. What level of BIM projects is your company currently able to produce?					
				Response Percent	Response Total
1	Level 0 - Unmanaged CAD typically 2D, with paper (or 'electronic ink') exchanged between participants.			22.50%	9
2	Level 1 - Managed CAD in 2D or 3D using BS 1192:2007 with a common data environment, but standalone commercial data management			32.50%	13
3	Level 2 - Managed 3D environment using separate discipline "BIM" tools with attached data and integrating commercial data			35.00%	14
4	Level 3 - iBIM or integrated BIM potentially accessing all available data forms, adding value in operation and supported by open standards.			7.50%	3
5	Not sure			15.00%	6
				answered	40
				skipped	0

9. What is the primary design function for which your firm uses BIM software?(Please check all that apply)				
			Response Percent	Response Total
1	Concept Design Development		40.00%	16
2	Renderings & Perspectives		40.00%	16
3	Schematics		17.50%	7
4	Construction Documents		32.50%	13
5	Design & Build Documents		15.00%	6
6	Fully Integrated Use (Concept to Construction)		27.50%	11
7	I'm not sure		25.00%	10
8	Other (please specify):		5.00%	2
			answered	40
			skipped	0
<b>Answers for: Other (please specify):</b>			<i>2 answers</i>	
1	01/05/14 8:26AM ID: 10329882	N/A		
2	06/05/14 1:11PM ID: 10378931	none as yet!		

10. Which BIM tool(s) (software) do you use for your projects? (Please check all that apply).				
			Response Percent	Response Total
1	Revit		72.50%	29
2	Bentley		2.50%	1
3	VICO		2.50%	1
4	Graphisoft Archicad		2.50%	1
5	Bentley Generative Components		2.50%	1
6	Nemetschek Vectorworks		2.50%	1
7	Tekla		20.00%	8
8	Other (please specify):		35.00%	14
			answered	40
			skipped	0

11. How many personnel do you have dedicated to BIM?					
				Response Percent	Response Total
1	0			40.00%	16
2	1-3			20.00%	8
3	3-5			10.00%	4
4	5-10			12.50%	5
5	10+			17.50%	7
				answered	40
				skipped	0

12. How many projects have you completed using BIM?					
				Response Percent	Response Total
1	0			52.50%	21
2	1-3			17.50%	7
3	3-5			2.50%	1
4	5-10			15.00%	6
5	10+			12.50%	5
				answered	40
				skipped	0

14. Do you have a development plan within your company for making the change to BIM?					
				Response Percent	Response Total
1	Yes			57.50%	23
2	No			22.50%	9
3	Don't know			20.00%	8
				answered	40
				skipped	0
<b>Answers for: If yes please briefly describe the development plan</b>				<i>11 answers</i>	
1	30/04/14 6:59PM ID: 10325921	Designer Leaders championing change			
2	01/05/14 8:59AM ID: 10330417	Design Director is currently looking into expanding BIM to all designers			
3	01/05/14 10:57AM ID: 10332635	Over the next 6 months training and buying software. Within next 12 months offering drawing service in BIM			
4	01/05/14 5:26PM ID: 10338702	I am personally not fully involved in that development plan			
5	06/05/14 1:11PM ID: 10378931	We are just starting to get to grips with our customers demands for BIM. 2 people have been to introductory courses. We currently intend subbing out what must be done in a format suitable for inclusion in BIM models but have not yet completed a job. We are involved in one major project that demands input to a BIM.			
6	06/05/14 5:13PM ID: 10383131	Intention to utilise BIM on all projects			
7	08/05/14 11:21AM ID: 10406811	AIL 360 training and development plan			
8	16/05/14 4:56PM ID: 10519669	Have recently merged with Swanke Heyden Connel who already use it from conception to delivery of finished building. They therefore have plan already in place. Two projects currently being developed using BIM approach.			
9	19/05/14 8:44AM ID: 10551036	We value assess implementation on every job, we are running internal/ex6ternal training, we have a support team for implementation (working with our braoder project partners) etc etc			
10	20/05/14 9:31AM ID: 10573415	Whole team now dedicated to delivery of BIM			
11	22/05/14 12:49PM ID: 10608108	I don't have details but can find them if required			

15. What do you think is the key to successful BIM implementation?				
			Response Percent	Response Total
1	Open-Ended Question		100.00%	31
1	30/04/14 6:59PM ID: 10325921	Understanding & training of designers		
2	30/04/14 11:38PM ID: 10328119	Was not aware of BIM, so unable to comment.		
3	01/05/14 7:09AM ID: 10329389	To be made more accessible to general users, at lower costs. Introduction of a light version that does not require a very high spec machine to run.		
4	01/05/14 7:35AM ID: 10329536	Training and more awareness of what is required.		
5	01/05/14 8:17AM ID: 10329809	Total integration from the trades and design team at the earliest opportunity.		
6	01/05/14 8:43AM ID: 10330081	Client led directive.		
7	01/05/14 8:59AM ID: 10330417	Full understanding of how it works and all designers using it in the same way.		
8	01/05/14 10:57AM ID: 10332635	I am not sure I have got no experience using BIM yet.		
9	01/05/14 3:12PM ID: 10336684	know something about it. do something about it		
10	01/05/14 5:26PM ID: 10338702	The integrated planning approach		
11	02/05/14 5:09PM ID: 10351559	1. Fully coordinated details from Architectural concept. 2. SE use architects model and overlay structure. 3. Specialist subcontractors add their elements. 4. Architect fully coordinate all trades. 5. Adequate time for coordination before manufacture or installation.		
12	06/05/14 8:14AM ID: 10374117	buy in from all parties (client, design consultants, main contractors, supply chain) at early outset of projects. Most companies are in the process of starting the journey - investment on both time & resource is required.		
13	06/05/14 1:11PM ID: 10378931	Realisation that there is no alternative and getting on with it! It's a significant step but there doesn't seem to be a coordinated industry-wide approach. Perhaps a set of step by step CITB monitored courses for various job functions or levels.		
14	06/05/14 5:13PM ID: 10383131	Collaborative working and buy-in from design team and sub-contractors. Early commencement of BIM at RIBA Stage A Training in BIM implementation to all staff. Utilisation of the models by all project staff.		
15	08/05/14 11:21AM ID: 10406811	A full understanding of requirements from all parties then a constant monitoring of this process		

A research and delivery foundation for the facade design process utilising BIM

16	16/05/14 4:56PM ID: 10519669	Good BIM execution Plan and clear understanding within design team as to what level of information is required to be delivered at end of project.	
17	17/05/14 10:54AM ID: 10533807	1/. A person or team dedicated to overseeing and managing the overall process/model?  2/. Companies should be looking at having dedicated individuals appropriately trained in the use of BIM well in advance of the 2016 mandatory implementation of the scheme.	
18	19/05/14 8:44AM ID: 10551036	Capability and buy-in are big challenges but so it the contractual position contractors find themselves in (we inherit pre-written appointments and design teams with services/fees pre-agreed). The supply chain is very fragmented (and they have a journey to go on). The technology isn't mature . . . there are many many challenges which fall into the people, process and technology bubbles. It is a change programme and therefore the willingness and comittment is perhaps one of the biggest barriers	
19	20/05/14 9:31AM ID: 10573415	Ensuring the industry buys into this during tender/design & procurment	
20	20/05/14 12:08PM ID: 10577107	We are at the beginning of understanding BIM and we have our first project going through planning. I guess the key to success of BIM is to use suitably qualified and trained consultants and to facilitate the full co-ordinationof the design team and client throughout the design process.	
21	22/05/14 12:49PM ID: 10608108	Buy-in to the process by all parties including client (who will be paying for it in the end). Also project programmes need to accommodate the learning curve most people with require to use BIM meaningfully - at present there's no sign of programmes taking this into account.	
22	01/06/14 9:26AM ID: 10716582	A good execution plan!	
23	01/06/14 9:28AM ID: 10716596	Early involvement of specalist trades	
24	01/06/14 9:31AM ID: 10716625	Early involvement of specalist contractors and good execution plan in place	
25	01/06/14 11:46AM ID: 10717658	A detailed execution plan	
26	01/06/14 11:48AM ID: 10717676	Need to fully understand what level 2 BIM is in terms of its processes - good execution plan	
27	01/06/14 11:50AM ID: 10717690	A good exercution plan	
28	01/06/14 11:55AM ID: 10717732	trained staff and a good execution plan	
29	01/06/14 11:56AM ID: 10717740	not sure	
30	01/06/14 11:58AM ID: 10717755	training of staff	
31	01/06/14 12:01PM ID: 10717775	A refined execution plan that can be adjusted to suit different projects - training of staff	
		answered	31
		skipped	9

9.4 Appendix 4: PAS1192-2-2013 BIM roles defined

Information management	Project delivery management	Lead designer	Task team manager	Task Information manager	Interface manager	Information originator
<b>Activities</b>						
Enable reliable Information exchange through a common data environment	Assure delivery of Information exchanges	Co-ordinated delivery of all design Information	Production of design outputs related to a discipline-specific, package-based or time-based task	Direct the production of task information in compliance with standards and methods	Manage spatial co-ordination on behalf of a task team	Develop constituent parts of the information model in connection with specific tasks
Maintain and receive Information into the Information Model	Confirm suppliers ability to deliver Information requirements	Manage Information development and Information approvals		Direct the production of task information using agreed systems	Propose resolutions to co-ordination clashes	Production of project outputs
Enable integration and co-ordination of Information within Information Model		Confirm design deliverables				
Configure Information for Project Outputs		Overall lead for configuration management				
Populate the Information exchange format for the Information Model						
Accept reject Information exchanges within the common data environment	Accept reject Information exchanges within the common data environment	Confirm status and approve Information for Issue within the common data environment	Issue approved Information within the common data environment	Confirm that Information is suitable for Issue within a common data environment	Propose resolutions to clashes	Ownership of model Information
No design responsibility or right to Issue instructions		Approve design changes proposed to resolve clashes				



## 9.5 Appendix 5: PAS 1192-2-2013 Design status codes

### PAS 1192-2:2013

#### 9.2.3 Status codes in the common data environment (CDE) (data definitions for the CDE)

The specialist contractors and designers shall use the same processes and status as for the professional design development and co-ordination procedures.

The specialist contractor and construction process status codes are shown in Table 3.

*NOTE 3 Additional codes have been introduced to allow for the delivery of the PIM and AIM plus the manufacturing models or documentation sign-off process.*

**Table 3 – Status codes in the CDE**

Status	Description
<b>Work in Progress (WIP)</b>	
S0	Initial status or WIP Master document index of file identifiers uploaded into the extranet.
<b>Shared</b>	
S1	Issued for co-ordination The file is available to be "shared" and used by other disciplines as a background for their information.
S2	Issued for information
S3	Issued for internal review and comment
S4	Issued for construction approval
S5	Issued for manufacture
S6	Issued for PIM authorization (Information Exchanges 1-3)
S7	Issued for AIM authorization (Information Exchange 6)
D1	Issued for costing
D2	Issued for tender
D3	Issued for contractor design
D4	Issued for manufacture/procurement
AM	As maintained
<b>Published documentation</b>	
A	Issued for construction
B	Partially signed-off: For construction with minor comments from the client. All minor comments should be indicated by the insertion of a cloud and a statement of "in abeyance" until the comment is resolved, then resubmitted for full authorization.
AB	As-built handover documentation, PDF, native models, COBie, etc.

*NOTE 1 Additional codes S6 and S7 are highlighted.*

*NOTE 2 Status codes are provided by information originators to define how information may be used during different phases of the CDE. The SHARED suitability codes are stated as "Issued for..." but this does not infer any contractual or insurable purpose. Their purpose is to limit the reuse of the information at that stage. See also BS 1192 and Building Information Modelling – A Standard Framework and Guide to BS 1192, Richards, 2010.*

*NOTE 3 Status codes are used in connection with the gateways in the CDE. They are not related to version numbering, the levels of detail or the stages in the plan of work.*