

# CIBSE ASHRAE Group

## Data Centre Energy Efficiency: Who, What, Why, When, Where & How

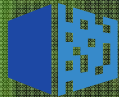

DIGITAL REALTY





# Presenters

---

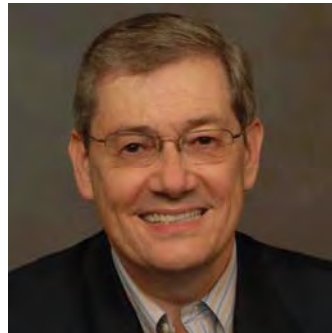

**Don Beaty** PE, FASHRAE  
Founder, President & Managing Director  
DLB Associates Consulting Engineers



**Paul Finch** CEng, FIMechE, MASHRAE  
Senior Director, Technical | Design & Construction  
Digital Realty



## Bio's

---



**Don Beaty** has over 30 years experience in consulting engineering and founded DLB Associates Consulting Engineers in 1980. He is a licensed professional engineer in over 40 states and has international licenses as well.

Don co-founded and was the first chair of ASHRAE Technical Committee TC 9.9 and currently serves as its Publications Chair. He is a frequent keynote speaker on behalf of ASHRAE TC 9.9 for the data centre industry, having presented over 100 times and in more than 25 countries on various data centre-centric topics.



**Paul Finch** is a senior engineering and construction executive and has extensive global experience across the full spectrum of development management and complex engineering led capital projects and operations, with a particular focus on the design, construction and operation of data centres, technical real estate and high dependency mission critical assets and infrastructure projects, across the telecommunications, technology and banking & financial services sectors.

Paul is a Voting Committee Board Member of ASHRAE Technical Committee (TC) 9.9 - *Mission Critical Facilities, Data Centres, Technology Spaces and Electronic Equipment*.



# Table of Contents

1. Some Data Centre Basics
2. Key Trends within the Data Centre Industry
3. Energy Standards & Regulations
4. Measurement of Data Centre Energy
5. Best Practices for Efficient Operation
6. Innovative Concepts & Solutions
7. Further Reading & Reference Publications
8. Q&A





A wide-angle, high-angle photograph of a data center. The room is filled with rows of server racks, illuminated with a cool blue light. The ceiling is a complex network of metal beams and pipes, with numerous overhead lights. The floor is a light-colored, polished tile. The overall atmosphere is clean, organized, and technologically advanced.

1

## Some Data Centre Basics



# Some Data Centre Basics

## Data Centre Graphical Overview

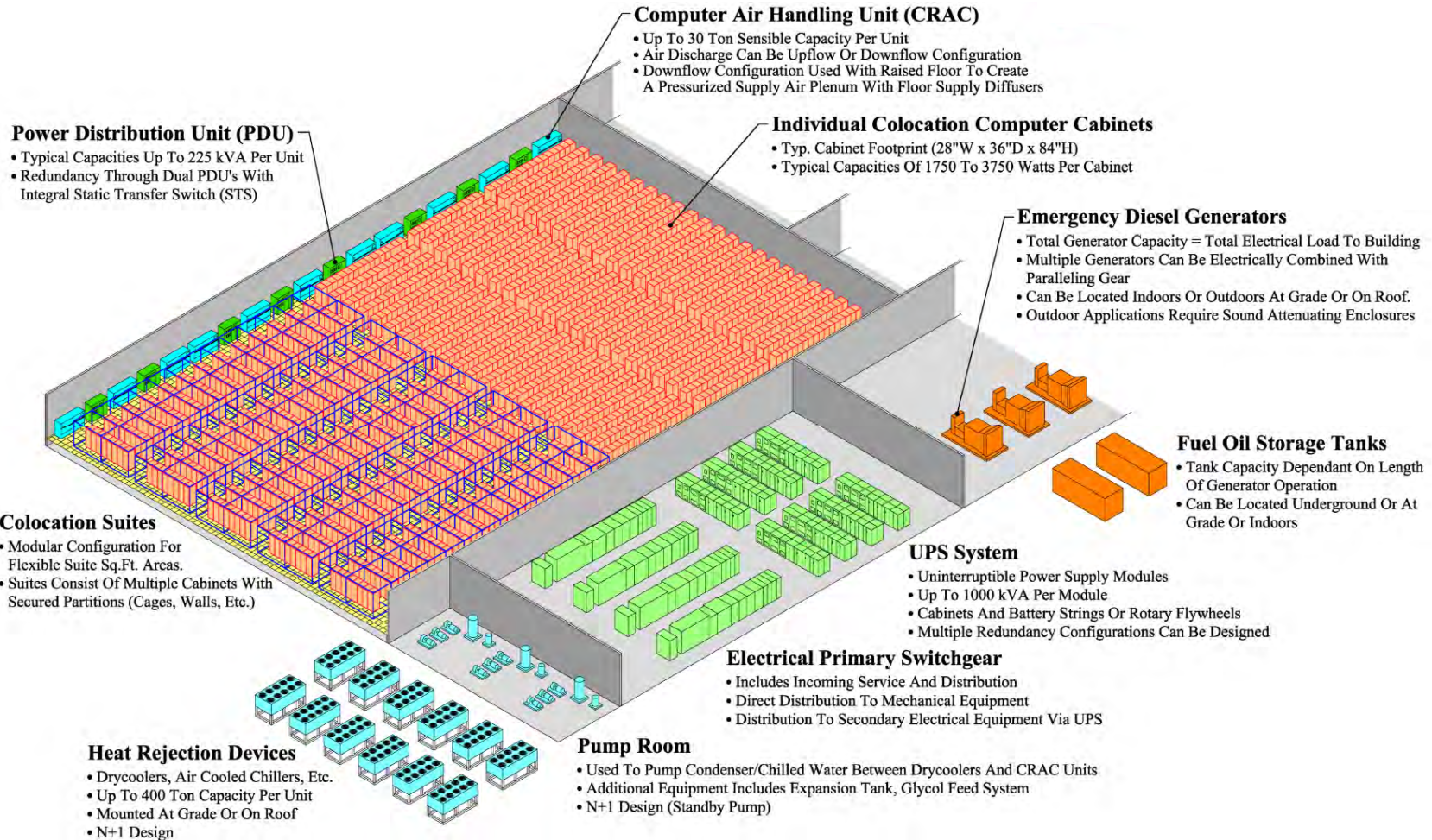

# Some Data Centre Basics

## Data Centre Occupants and Fixtures, Furnishings & Equipment (FF&E)



**Conventional Buildings**  
*Human Occupants*



**Data Centres**  
*Software Occupants*





# Some Data Centre Basics

## Computer Cabinets & Racks





# Some Data Centre Basics

## Server Configurations



**Tower Server**  
(tall & narrow)

**1U Server**  
(short & wide)

**Blade Server**  
(square)

**Freestanding**

**Rack Mounted**



# Some Data Centre Basics

## Hardware, System Software & Application Software

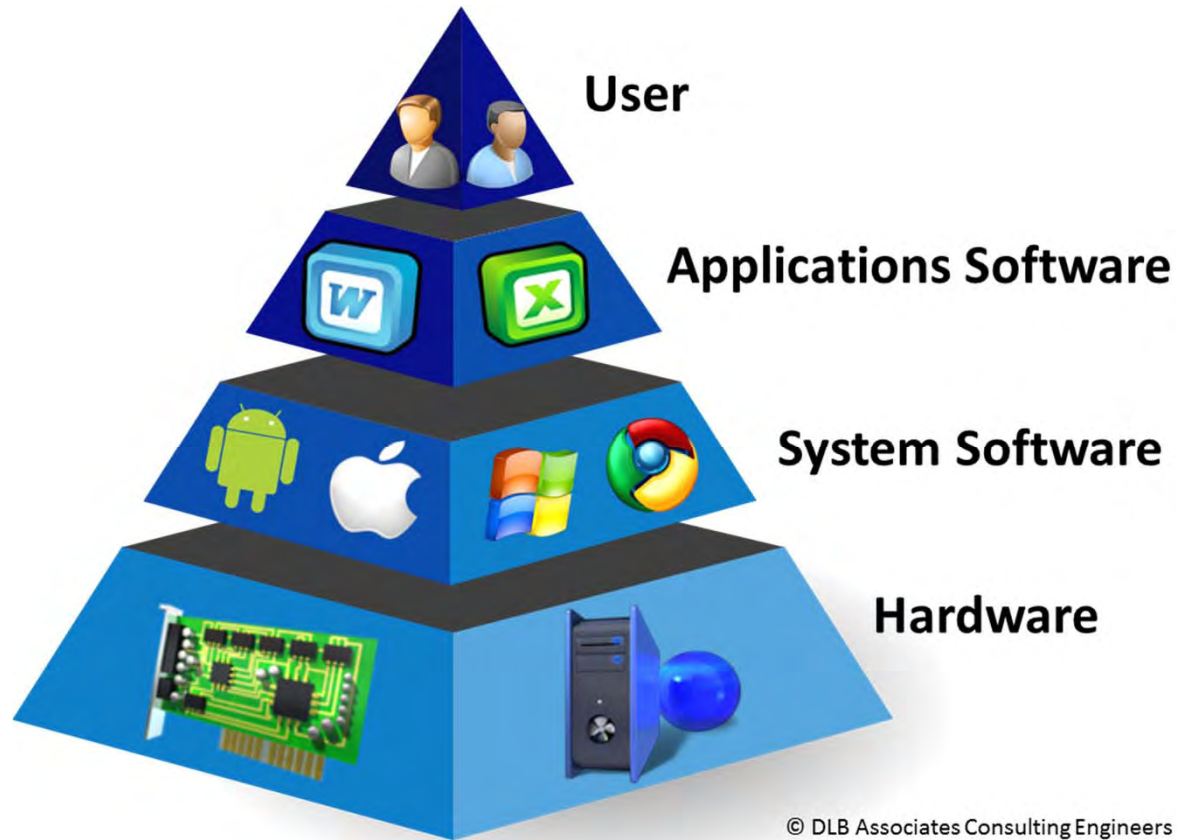

© DLB Associates Consulting Engineers





2

Key Trends in  
the Data Centre  
Industry



# Key Trends in the Data Centre Industry

## 2000 & 2005 IT Equipment Power – Predictive Trends

© Uptime Institute Graphic Modified By DLB

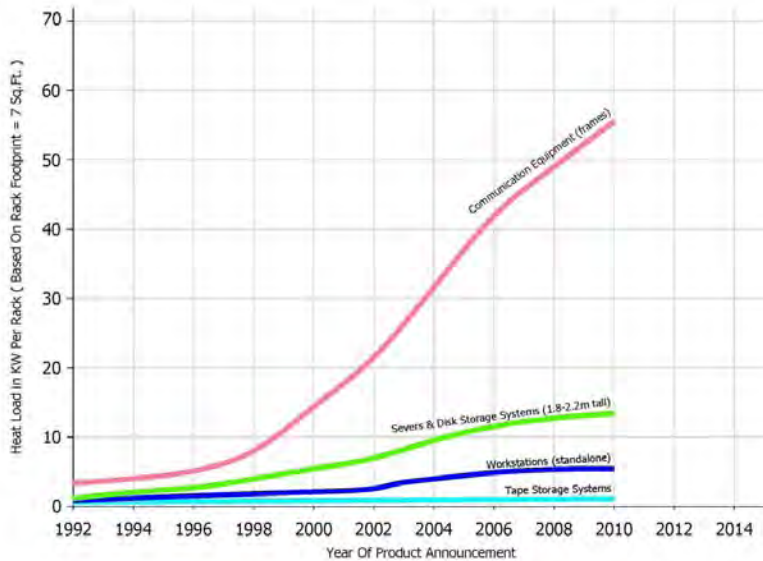

© ASHRAE Graphic Modified By DLB

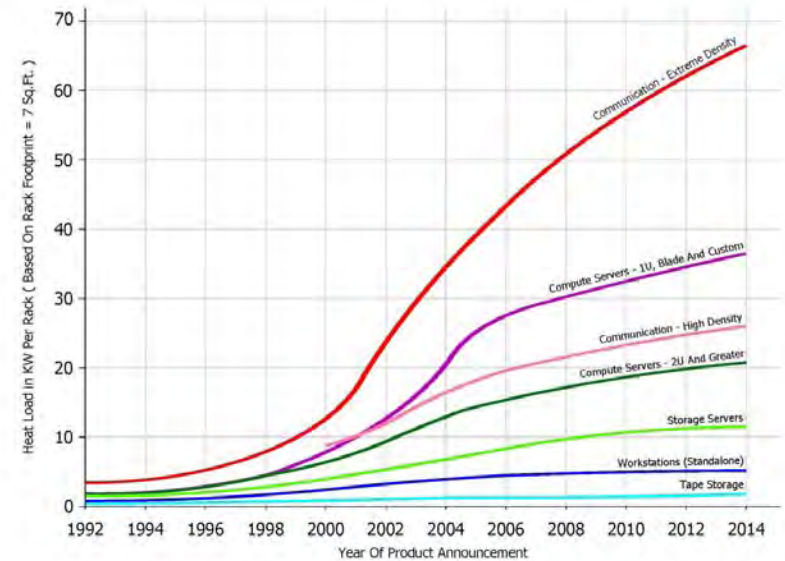

**Thermal Management Consortium in 2000:**  
*Published Through The Uptime Institute*

**ASHRAE 2005 Publication:**  
*Datacom Equipment Power Trends  
 & Cooling Applications*

**History Validated these Trends**



# Key Trends in the Data Centre Industry

## Data Center Generational Impact – 2007 to 2011

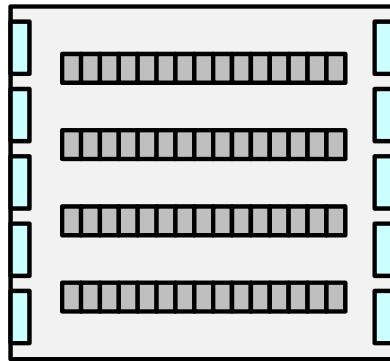

Generation 1

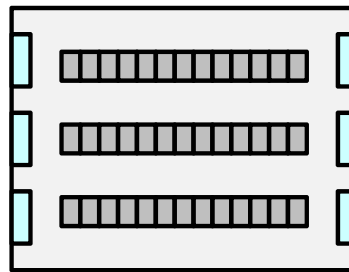

Generation 2

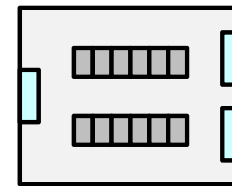

Generation 3

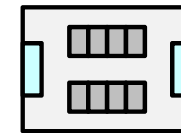

Generation 4

**Generation 1 to 4 have the SAME IT Performance**

© IBM

Metric	Comparative Change (4U, 4 Processor)		
	Generation 1 (Year 1 – Baseline)	Generation 4 (Year 4)	Generation 1 to 4 Comparison
IT Performance	100%	100%	SAME
IT Power per Rack	100%	119%	+ 19%
Rack Count	100% (60)	13% (8)	- 87%
Total IT Power	100%	18%	- 82%
Space Required	100%	15%	- 85%
Cooling Required	100%	20%	- 80%

# Key Trends in the Data Centre Industry

## ASHRAE Psychrometric Chart – 2011

- Classes A1 and A2 are EXACTLY the SAME as previous Classes 1 & 2: Apply to new AND legacy equipment
- New Classes A3 and A4 do NOT include legacy equipment

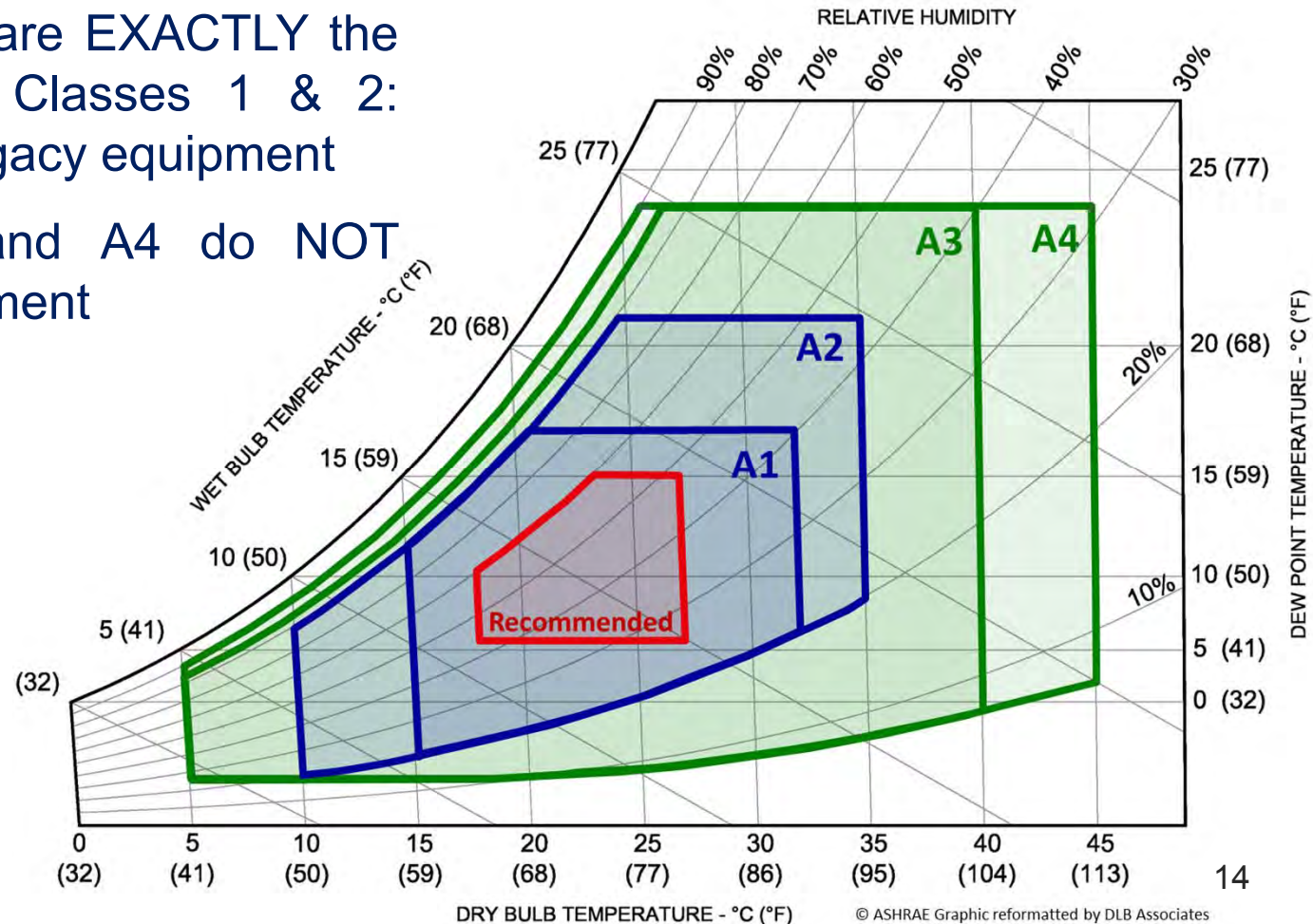



# Key Trends in the Data Centre Industry

## Volume Server Power Demand & Performance Growth

Volume Server Power Demand & Performance Growth (excludes extreme low energy servers)			
Volume Server	CAGR	Growth in 3 Years	Growth in 5 Years
Power Demand Growth	<b>2 to 6%</b>	<b>5 to 20%</b>	<b>10 to 30%</b>
Performance Growth	<b>25 to 30%</b>	<b>90 to 120%</b>	<b>200 – 250%</b>

Compounded Annual Growth Rate (CAGR)

Growth Projections are Rounded



# Key Trends in the Data Centre Industry

Volume Server Power Trends to 2020 (fully configured, fully utilized max load)

Height	No. of Sockets	Heat Load / Chassis (Watts)			Heat Load / 42U Rack			Increase 2010 to 2020
		2010	2015	2020	2010	2015	2020	
1U	1s	255	290	330	10,710	12,180	13,860	29%
	2s	600	735	870	25,200	30,870	36,540	45%
	4s	1,000	1,100	1,200	42,000	46,200	50,400	20%
2U	2s	750	1,100	1,250	15,750	23,100	26,250	67%
	4s	1,400	1,800	2,000	29,400	37,800	42,000	43%
4U	2s	2,300	3,100	3,300	23,000	31,000	33,000	43%
7U (Blade)	2s	5,500	6,500	7,500	33,000	39,000	45,000	36%
9U (Blade)	2s	6,500	8,000	9,500	26,000	32,000	38,000	46%

Market Requirements force IT manufacturers to maximize performance/volume (creating high heat load/rack). These rack heat loads will result in increased focus on improving data center ventilation solutions and localized liquid cooling solutions

**High Risk to Generalize; One Shoe Definitely Does NOT Fit All**

# Key Trends in the Data Centre Industry

## Volume Server Power Trends - Simple Adjustment Factor Example

Adjustment Factor	Volume Server Configuration	Heat Load / Chassis (Watts)			Heat Load / 42U Rack		
		2010	2015	2020	2010	2015	2020
1.00 (Original Value)	1U, 2s	600	735	870	25,200	30,870	36,540
<b>0.50</b> (Your Data Center)	1U, 2s	<b>300</b>	<b>368</b>	<b>435</b>	<b>12,600</b>	<b>15,435</b>	<b>18,270</b>

### How to adjust the published Trends for your environment:

- 1) Trend Chart Value for a 1U, 2s Volume Server in 2010: **600 Watts**
- 2) ACTUAL MEASURED Value for YOUR 1U, 2s Server: **300 Watts**
- 3) Calculated Adjustment Factor for YOUR 1U, 2s Server = **300 Watts / 600 Watts = 0.50**





# 3

## Energy Standards & Regulations



# Energy Standards & Regulations

## ASHRAE Standard 90.1 - 2013

- Purpose
- Scope
- Definitions, Abbreviations, and Acronyms
- Administration and Enforcement
- Building Envelope
- Heating, Ventilating, and Air Conditioning
- Service Water Heating
- Power
- Lighting
- Other Equipment
- Energy Cost Budget Method

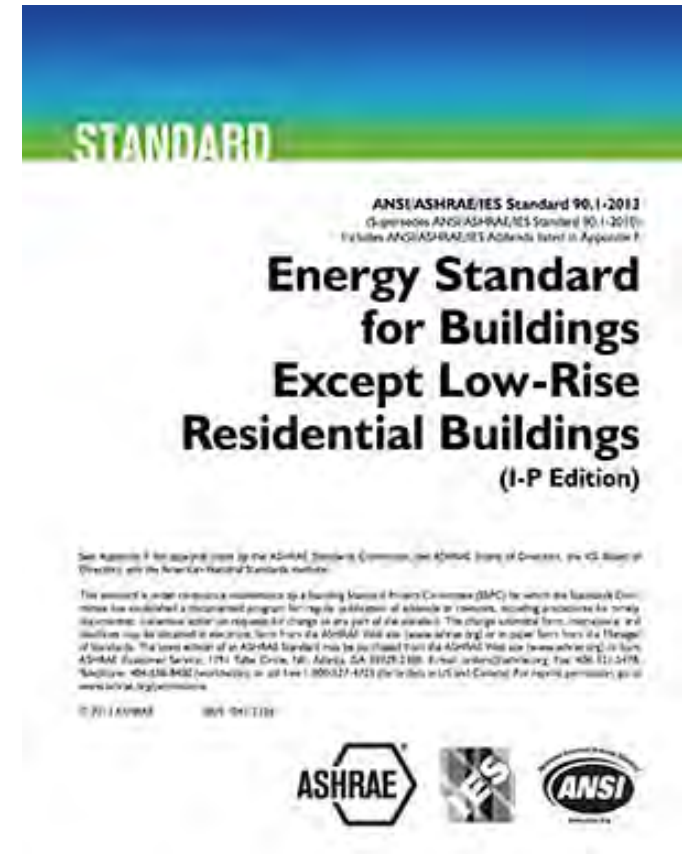

# Energy Standards & Regulations

## ASHRAE Standard 127 - 2012

- Purpose
- Scope
- Definitions
- Classification
- Rating Requirements
- Conformance
- References

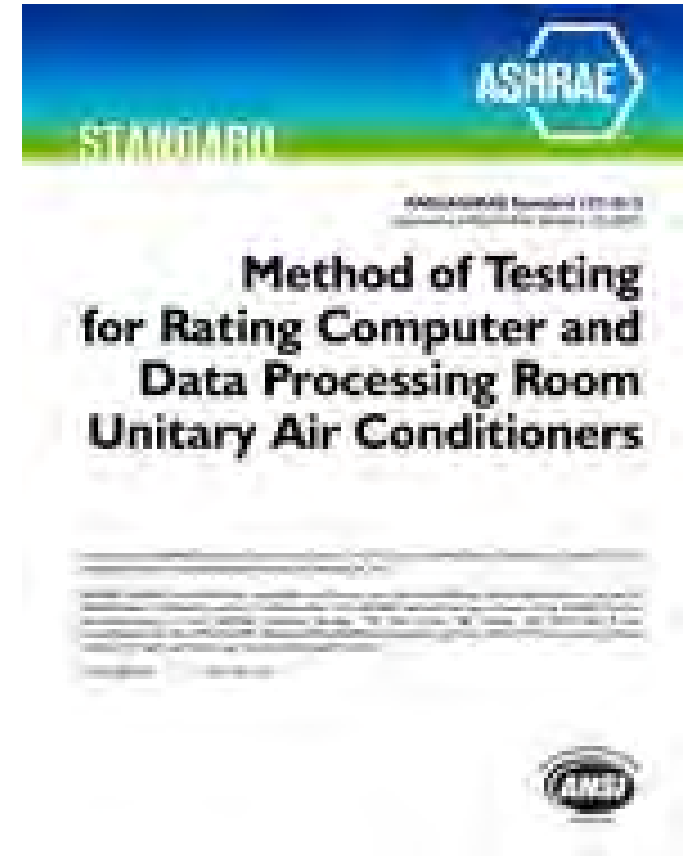



# Energy Standards & Regulations

## ASHRAE Thermal Guidelines for Data Processing Environments – 3rd Edition

- Introduction
- Environmental Guidelines for Air-Cooled Equip.
- Environmental Guidelines for Liquid-Cooled Equip.
- Facility Temperature & Humidity Measurement
- Equipment Placement & Airflow Patterns
- Equip. Manufacturers Heat & Airflow Reporting
- Appendices A – J

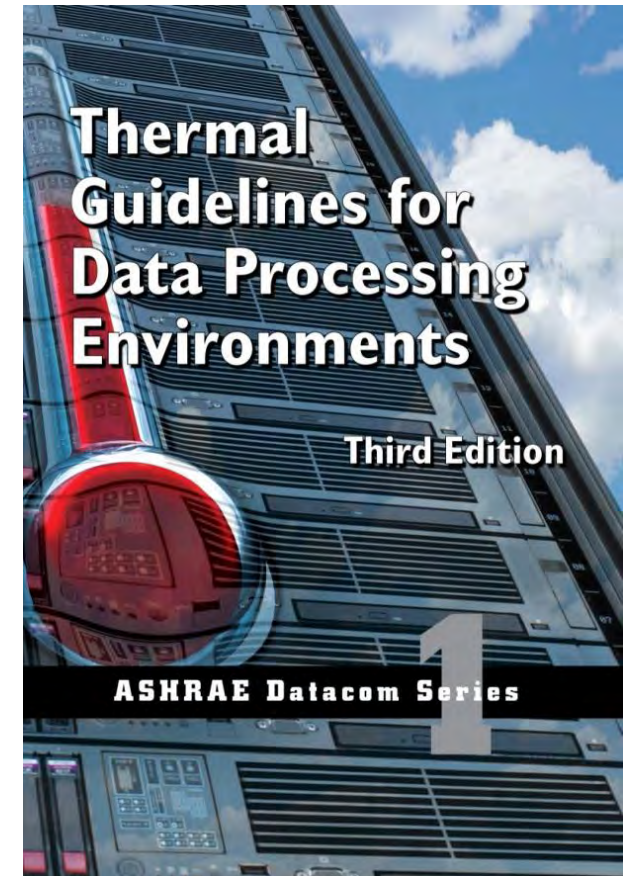

# 4

## Measurement of Data Centre Energy



# Measurement of Data Centre Energy

## PUE Basics

- PUE: Power Usage Effectiveness
- pPUE: Partial Power Usage Effectiveness
- PUE defined by The Green Grid (TGG)
- PUE is an annualised metric considering kWh not kW
- PUE can NEVER be  $<1.0$
- PUE does NOT receive credit for waste heat repurposes
- EUE (Energy Reuse Effectiveness) does consider waste heat





# Measurement of Data Centre Energy

## PUE & pPUE Definition

$$\text{PUE} = \frac{\text{Total Facility Energy}}{\text{IT Equipment Energy}}$$

$$\text{pPUE} = \frac{\text{Total Energy Inside The Boundary}}{\text{Total IT Equipment Energy Inside The Boundary}}$$



# Measurement of Data Centre Energy

## PUE Example

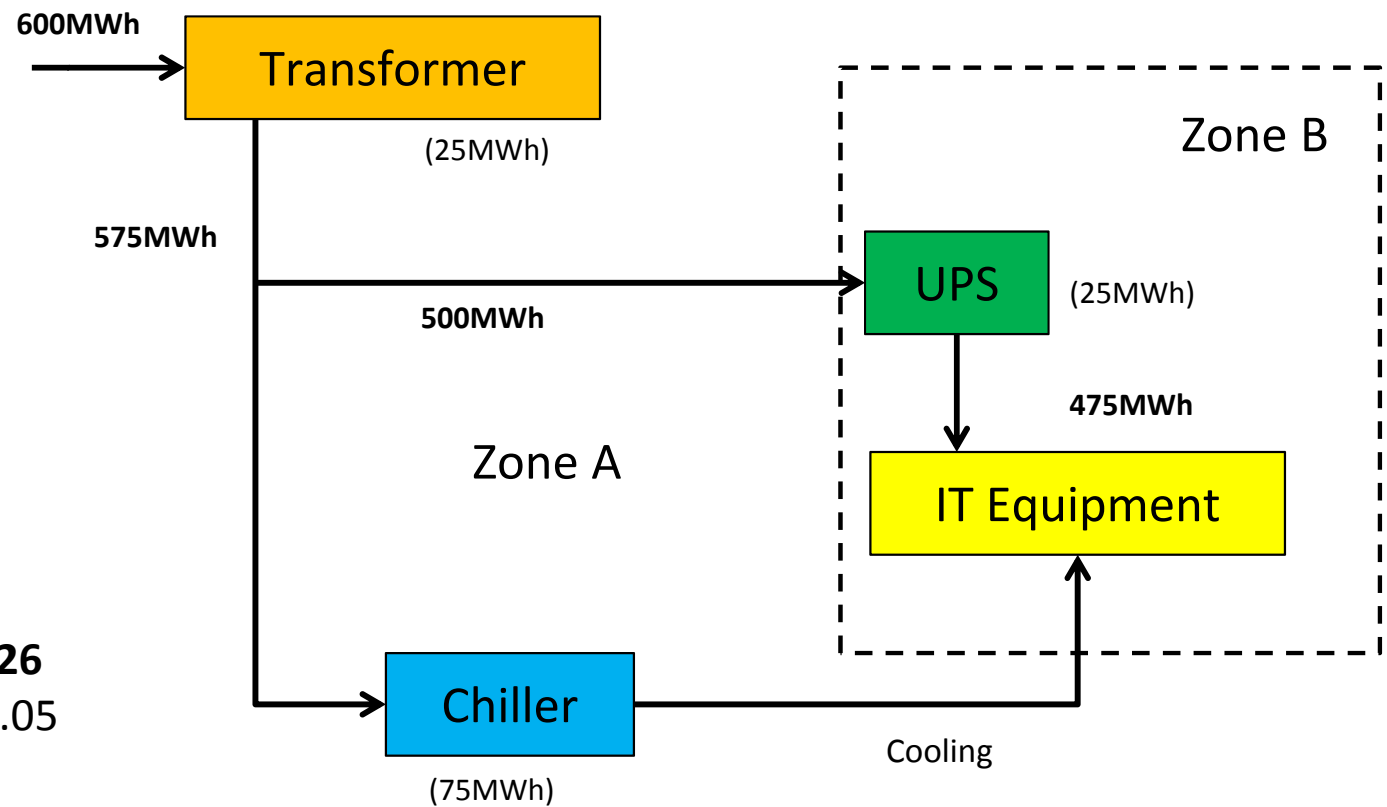

### Example:

$$\text{PUE (Zone A)} = 600/475 = 1.26$$

$$\text{pPUE (Zone B)} = 500/475 = 1.05$$



# Measurement of Data Centre Energy

## pPUE Example

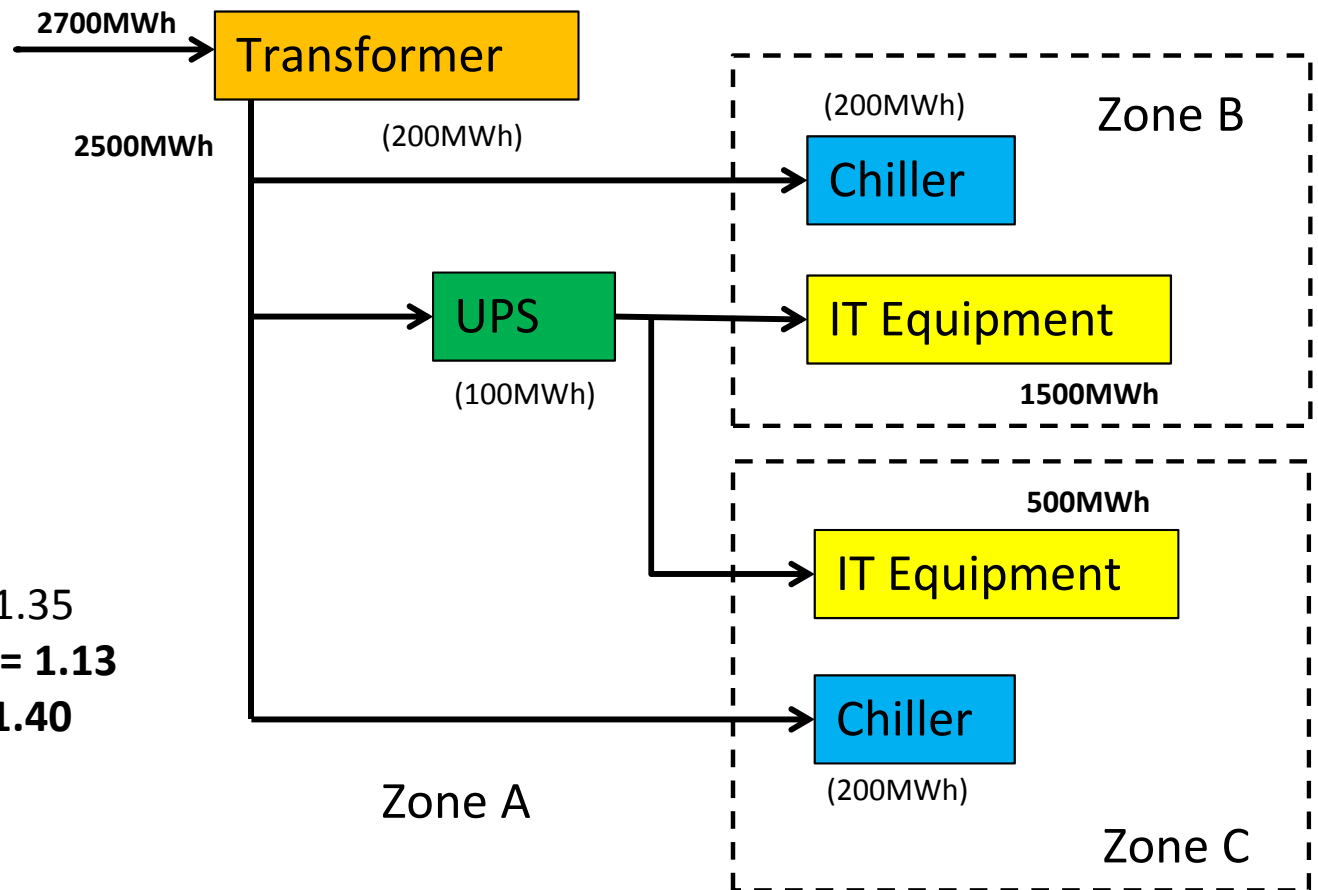

### Example:

$$\text{PUE (Zone A)} = 2700/2000 = 1.35$$

$$\text{pPUE}_1 \text{ (Zone B)} = 1700/1500 = 1.13$$

$$\text{pPUE}_2 \text{ (Zone C)} = 700/500 = 1.40$$





# Measurement of Data Centre Energy

## PUE Measurement

Three defined levels of PUE measurement being:

- PUE<sub>1</sub> (Level 1: Basic)
  - UPS Output, Utility Input, Monthly/Weekly
- PUE<sub>2</sub> (Level 2: Intermediate)
  - PDU Outputs, Utility Input, Daily/hourly
- PUE<sub>3</sub> (Level 3: Advanced)
  - IT Equipment Input, Utility Input, ≤15 minutes



# 5

## Best Practices for Efficient Operation



# Best Practices for Efficient Operation

## Design and Operational Opportunities

- **Energy Management:** measure performance, plant & equipment right-sizing.
- **Environmental Conditions:** optimise supply temperature and humidity control.
- **Air Flow Management:** improve return air management, separate hot and cold airstreams, Improve underfloor pressure management, Optimise IT cabinet airflow, Improve CRAH, CRAC, AHU efficiency.
- **Cooling Plant:** variable speed drives, cooling plant strategies, increase water efficiency, optimise pumping control, use of waste heat, optimise chilled water and condenser water supply temperatures, improve pumping efficiency, direct expansion vs. chilled water
- **Power:** improve UPS efficiency, improve transformer efficiency, minimise power distribution routes.
- **Lighting:** Improve lighting efficiency.
- **IT Equipment:** implement server virtualisation, optimise data storage, enable power management features, specify high efficiency power supplies, IT infrastructure right-sizing.





# 6

## Innovative Concepts & Solutions



## Innovative Concepts & Solutions

### Degree of Applicability Varies from Project to Project

- Thermal Guidelines for Data Processing Environments (2011) – adoption of the Allowable Range & X-Factors
- Compressor-less cooling solutions
- Application of in-direct outside air
- High Performance Computing (HPC) liquid cooling technologies – full oil emersion, processor heat-sink and closed-coupled heat exchangers
- Decentralised UPS
- Fine granularity phasing (e.g. one row at a time)
- Minimise the number of end-to-end voltage transitions



7

# Further Reading





# Further Reading & Reference Publications

## ASHRAE Datacom Series

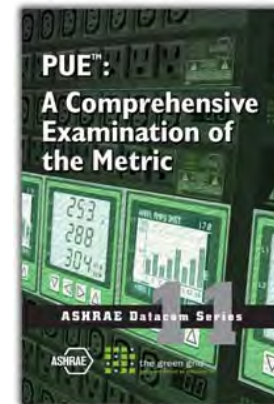
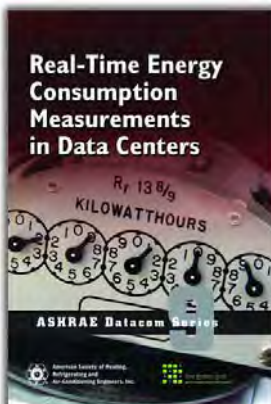
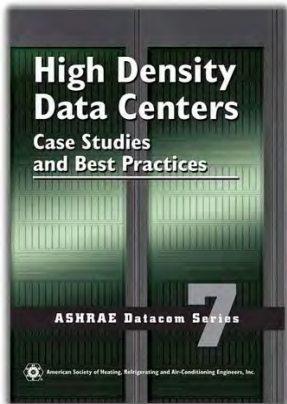
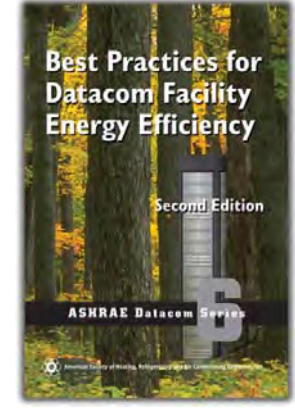
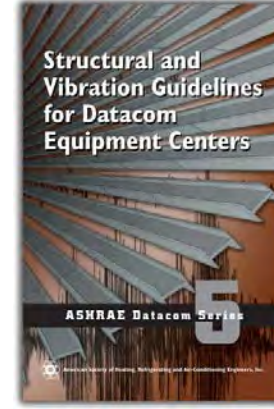
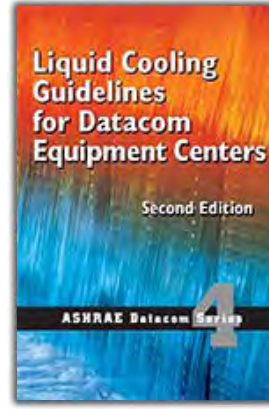
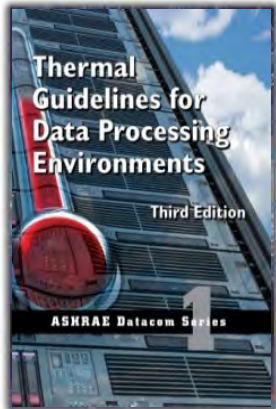

[www.tc99.ashraetcs.org](http://www.tc99.ashraetcs.org)

[www.ashrae.org](http://www.ashrae.org)





8

# Question & Answers



# THANK YOU

---



**Don Beaty PE, FASHRAE**  
Founder, President & Managing Director  
+1 732 927 5000  
[dbeaty@dlbassociates.com](mailto:dbeaty@dlbassociates.com)  
265 Industrial Way West, Eatontown, NJ 07724, USA  
+1 732 774 2000  
[www.dlbassociates.com](http://www.dlbassociates.com)



**Paul Finch CEng, FIMechE, MASHRAE**  
Senior Director, Technical | Design & Construction  
+44 (0) 7984 912 258  
[pfinch@digitalrealty.com](mailto:pfinch@digitalrealty.com)  
Level 7, 40 Gracechurch Street, London EC3V 0BT, UK  
+44 (0)20 7954 9121  
[www.digitalrealty.com](http://www.digitalrealty.com)

